

Architectural Components for a Practical Quantum Computer:

John Kubiatoiwicz
University of California at Berkeley

QARC: The Quantum Architecture Research Center

- Four Researchers:
 - Fred Chong (UC Davis)
 - Isaac Chuang (MIT)
 - Mark Oskin (U Washington)
 - John Kubiatoiwicz (UC Berkeley)
- Funny quote on someone's web site:
 - "Perhaps appropriately, given the uncertainty principle that underpins quantum mechanics, this 'center' does not have a specific physical location, but is rather a community of several research labs led by Fred Chong, Isaac Chuang, and John Kubiatoiwicz."

IBM/Berkeley Day

QARCH:2

What does an architect (i.e. me) Think about?

- Big systems:
 - Millions or Billions of interacting elements
 - Not 7-10 bits
- Buildable systems:
 - Constructed from smaller, easily composed elements
 - Possible to verify functionality
 - Over 50% of modern design teams for verification
 - Verifying a quantum bit -- harder than asynchronous logic???
 - Easy to fabricate
- Programmable systems:
 - Can be directed to do some desired task
 - Easy use of abstraction, high-level languages, compilers
 - Could use automated programming techniques, but still need some human-specified goal set
 - Can be debugged

IBM/Berkeley Day

QARCH:3

Does this have any relevance to Quantum Computing?

- Big/Scalable?
 - Has to be something with easily repeatable units
 - Given current sophistication of fab technology:
 - This probably means silicon-based...?
- Buildable?
 - Components that we understand means:
That are bigger than a bit!
 - It also means that we can multiplex/reuse pieces
 - Possibly with CAD tools?
- Programmable?
 - Yeah, well

IBM/Berkeley Day

QARCH:4

Classical Computer Components

- Von Neumann architecture has:
 - Memory, CPU, Registers, I/O
 - Very powerful abstraction/good building blocks
- Physical Extent of components (say on 2-d chip):
 - Means that we need WIRES
- Ground/VDD?
 - Nice source of 0 and 1
- Signal preservation through coding
 - In principle could put ECC everywhere
- Extensive design flow:
 - CAD tools for producing circuits/laying them out/fabricating them, etc.

Start with Scalable Technology:

- Big interest in Kane proposal, for instance

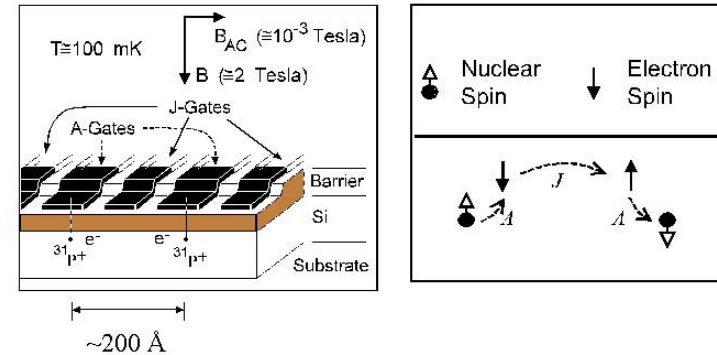

- Others certainly possible (No offense intended!)

Interesting problem: Classical Interface to Quantum Domain?

5nm access points contain only a handful of quantum states at temp < 1K

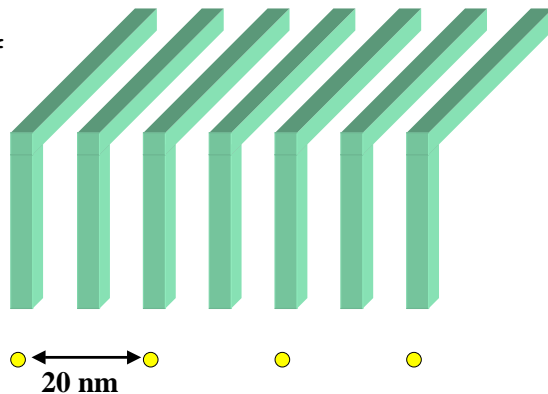

Perhaps a solution?

As two physical dimensions of the access point exceed 100nm thousands of electron states are held.

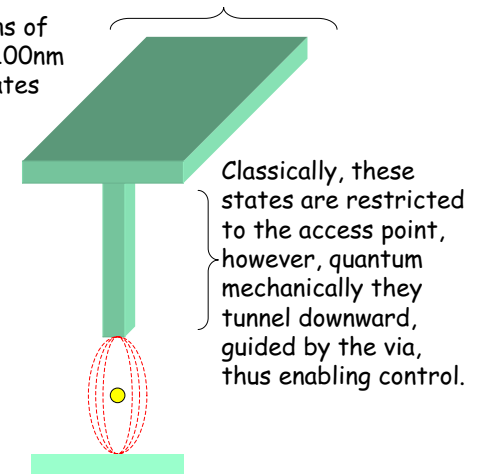

Pitch-matching nightmare??

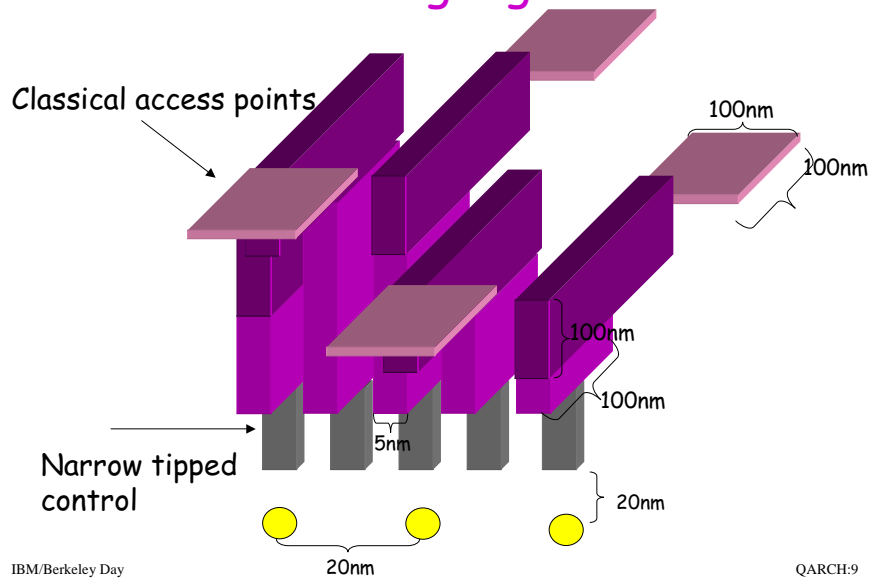

Example of Components: The Entropy Exchange Unit

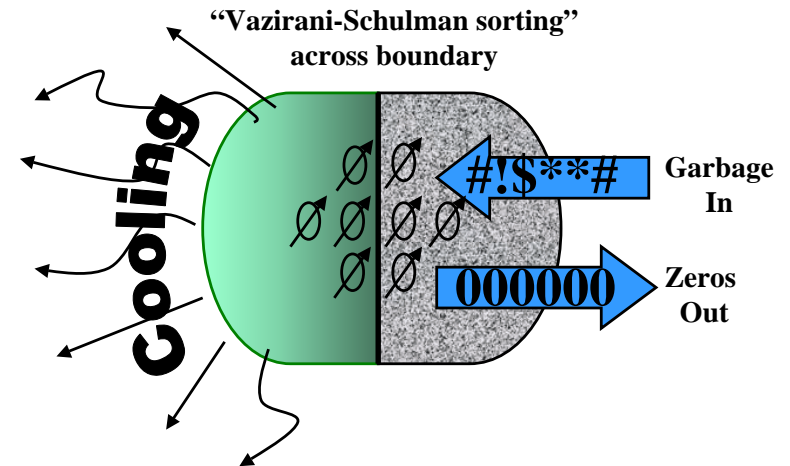

Why is this important?

- Initialized states (zeros, for instance) required for:
 - Initialization of Computation (not surprising)
 - Error correction (continuous consumption)
 - Long-distance quantum transport (wires)
- Entropy exchange probably needed *everywhere!*

What is involved here?

- Substrate capable of quantum computation
- Possibilities for cooling:
 - Spin-polarized photons \Rightarrow spin-polarized electrons \Rightarrow spin-polarized nucleons
 - Simple thermal cooling of some sort
- Two material domains:
 - One material in contact with environment
 - One material isolated
- Quantum computing across boundary
 - Ack! Most basic operation requires some computing

What about wires? A *short* quantum wire

- Key difference from classical:
 - quantum information must be protected/restored!!
 - Cannot copy information (no fanout)
 - Cannot (really) amplify this info
- Short wire constructed from swap gates
 - Each step requires 3 quantum-NOT ops (swap)

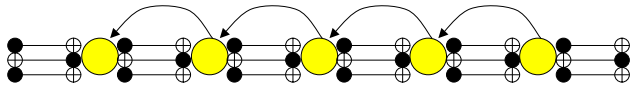

Why short wires are *short*

- Limited by decoherence
- Threshold theorem => distance
 - For some assumptions $\approx 1.8\text{mm}$ (very rough)
 - Very coarse bounds so far
- Can make longer with "repeater"?
 - Essentially this is multiple short wires Separated by error correction blocks

How to get longer wires??

- Use "Quantum Teleportation"
 - Transfers EPR pairs to either end of "wire"
 - Measures state at source, transfers bits to dest
 - Source bit destroyed at source, reconstructed at dest
- Key insight:
 - EPR pairs are *known* states
- No need to protect them
 - Purify the good ones
 - Discard the bad

Architecture of a long wire

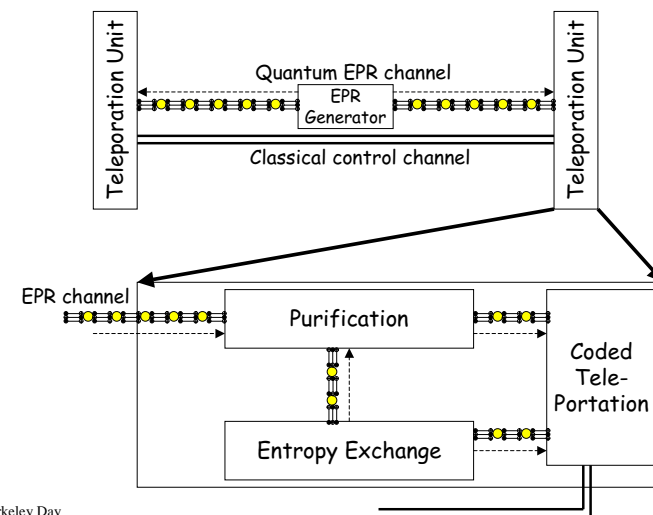

Long wires

- **COMPLEX!!!** Much computation at either end
 - Need to purify EPR pairs
 - Need to measure
- Can be of "arbitrary" length
 - A 10mm wire sustains nearly peak bandwidth
- Latency matches classical latency
 - Pre-communicate EPR pairs/pipeline purification
 - Latency is constant: teleportation operation
- Code-conversation for "free"
 - Facilitates Processor \leftrightarrow Memory communication [COC+02]

Conclusion

- Perhaps not too early for *Architects* to start thinking about quantum computing
- Important non-classical components:
 - Entropy exchange units/EPR generators
 - Wires: Multiple varieties
- Other things (I didn't even bother to talk about):
 - Memory/CPU, etc
 - CAD tools
 - Etc.
- Will we ever *really* have to worry about 1000s or millions of bits?
 - Hopefully