

Recording Action Potentials

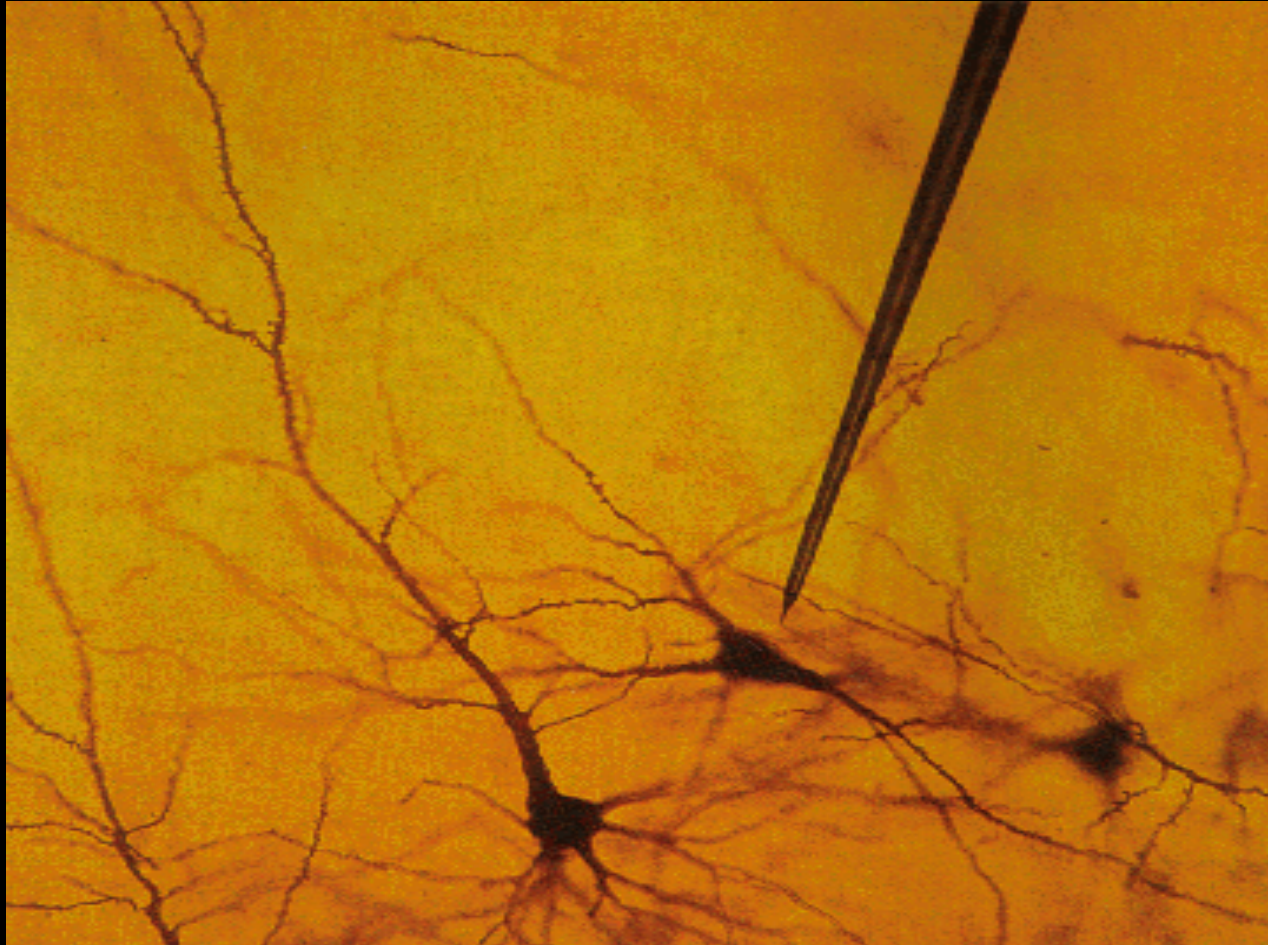

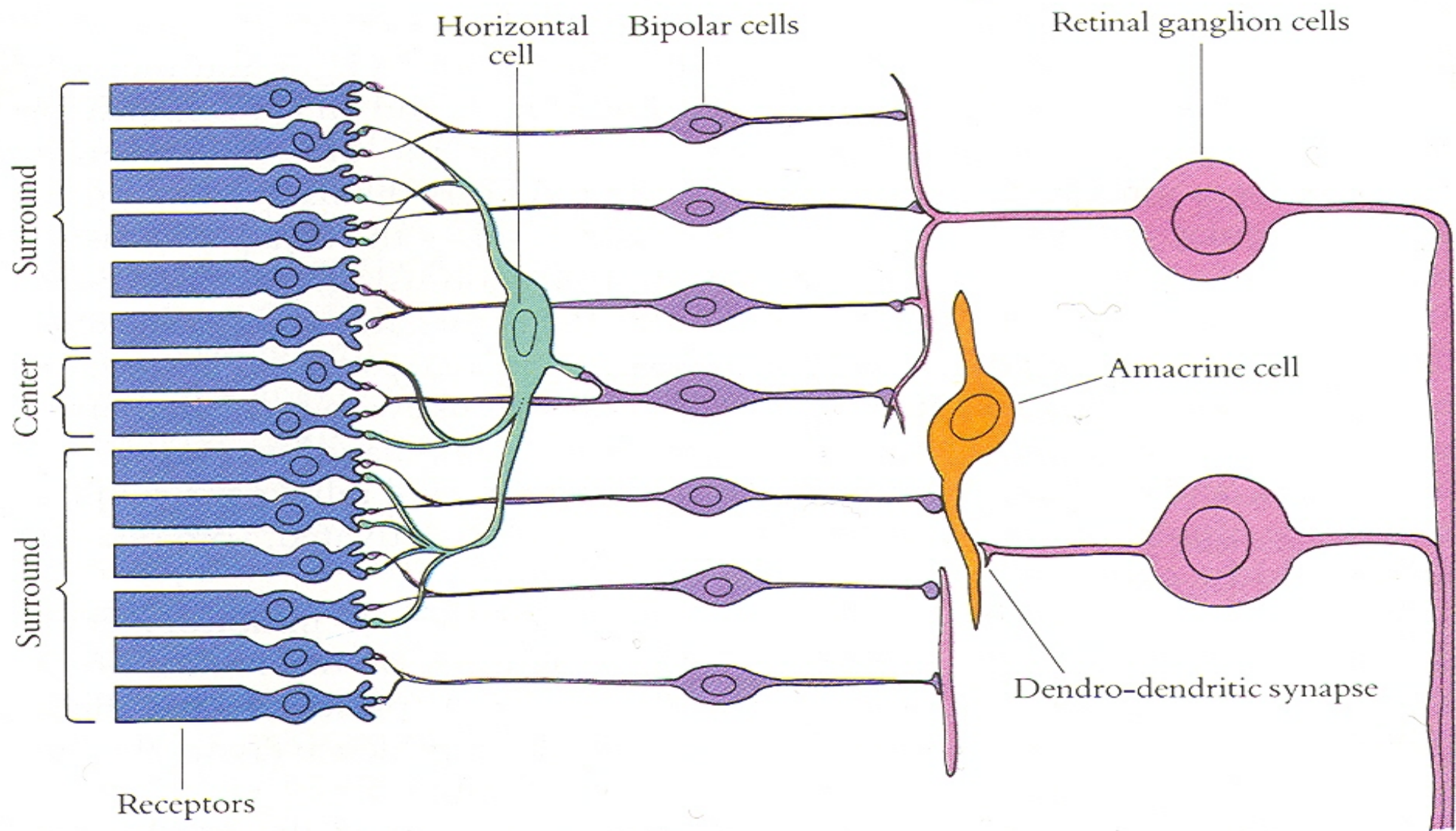

Receptive field structure in ganglion cells: On-center Off-surround

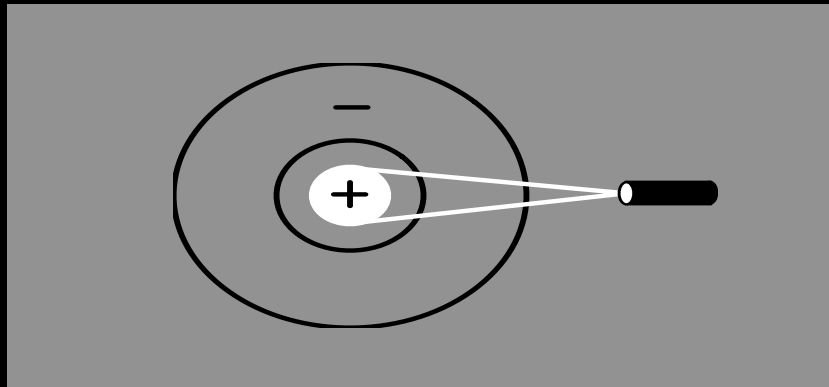

Stimulus

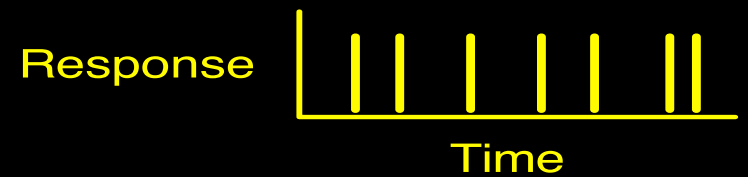

Electrical response

Receptive field structure in ganglion cells: On-center Off-surround

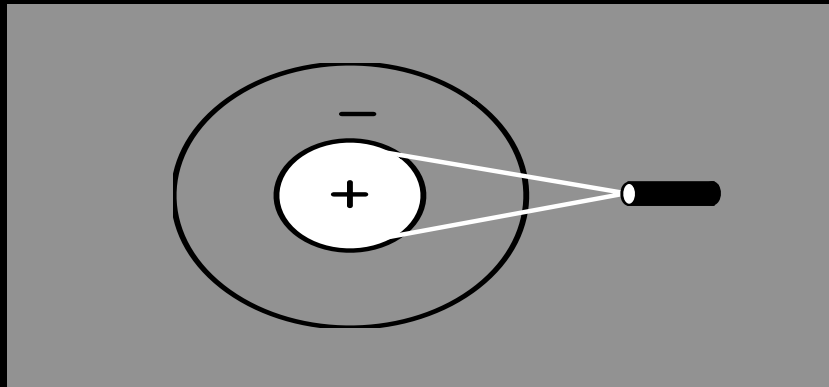

Stimulus condition

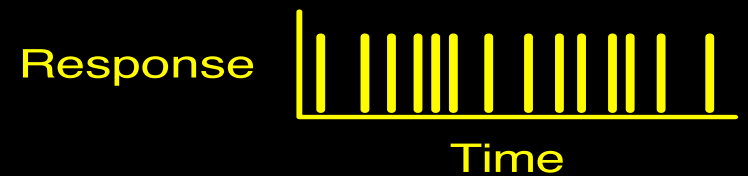

Electrical response

Receptive field structure in ganglion cells: On-center Off-surround

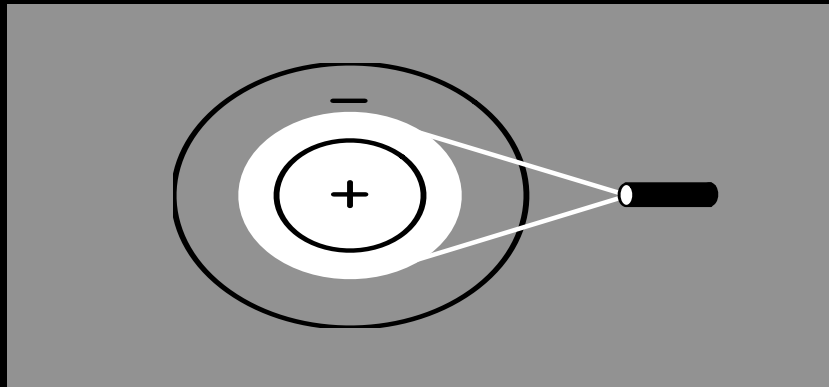

Stimulus condition

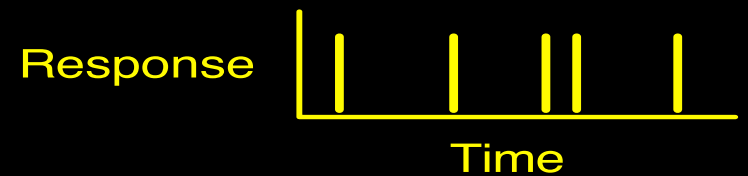

Electrical response

Receptive field structure in ganglion cells: On-center Off-surround

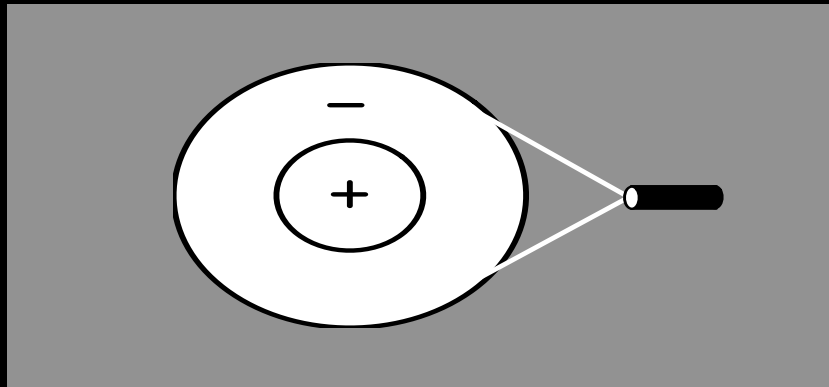

Stimulus condition

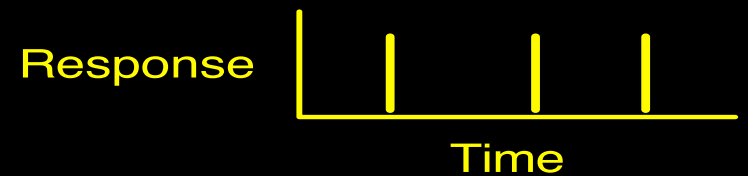

Electrical response

On-center Off-surround cells

Receptive Field

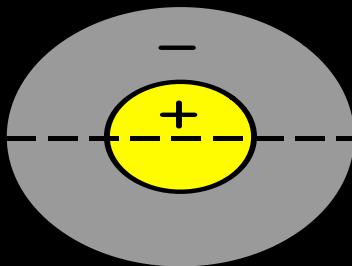

Response Profile

Firing Rate

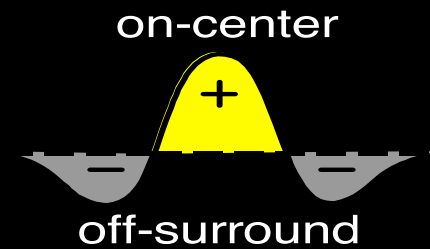

Horizontal Position

Off-center On-surround cells

Receptive Field

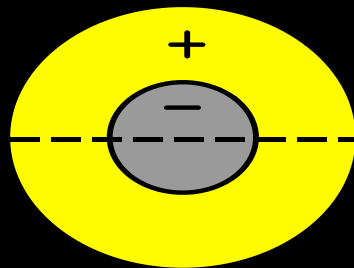

Response Profile

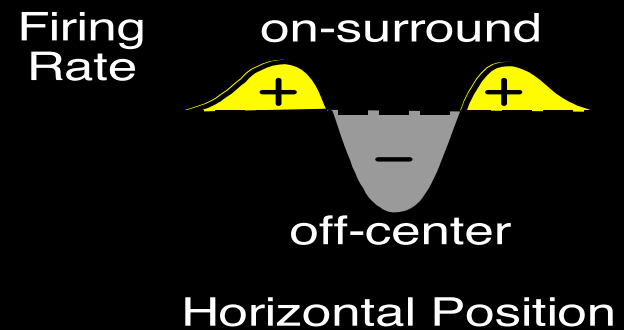

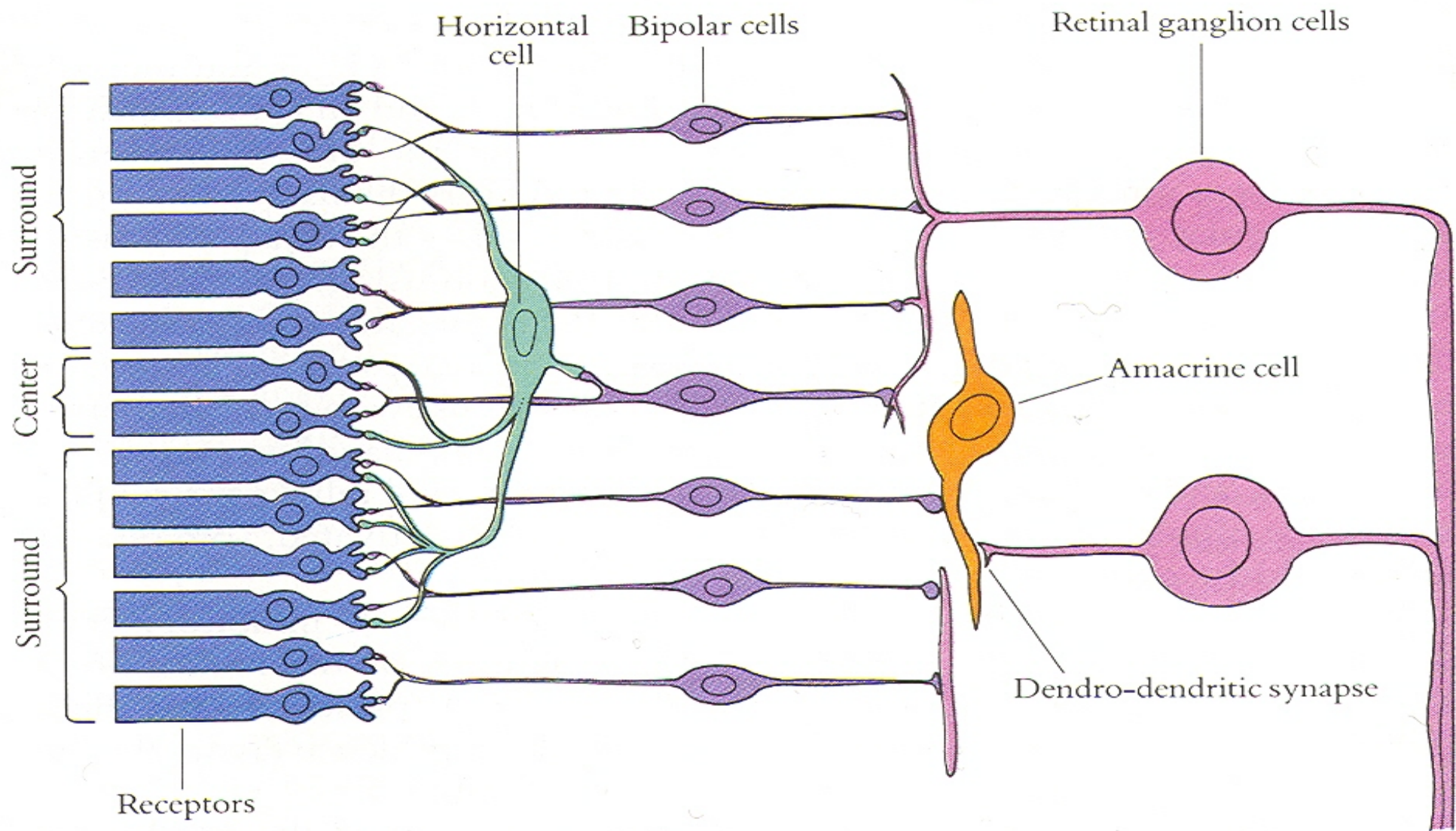

Cortical Area V1 aka Primary Visual Cortex

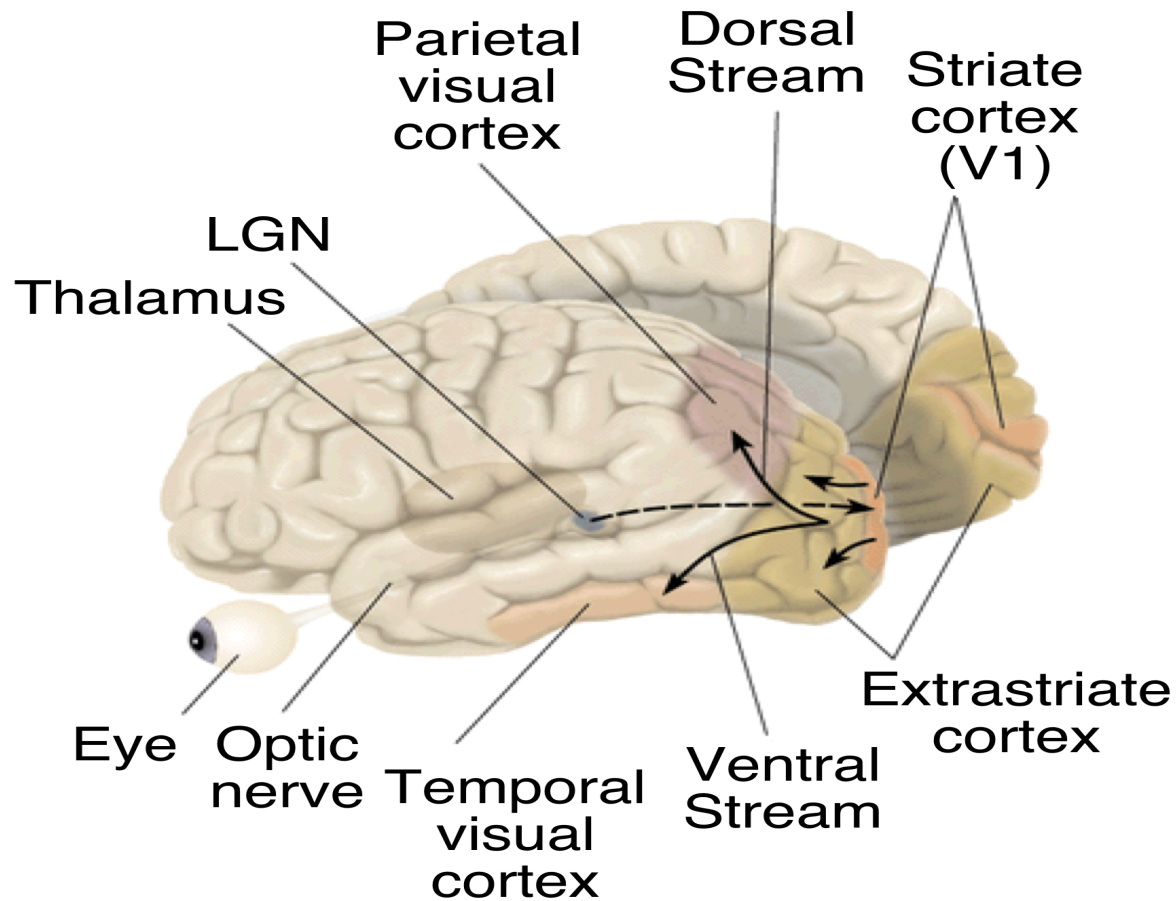

Single-Cell Recording from Visual Cortex



David Hubel & Thorston Wiesel

2 Classes of Cells in V1

Simple cells

Complex cells

Simple Cells: Line Detectors

A. Light Line Detector

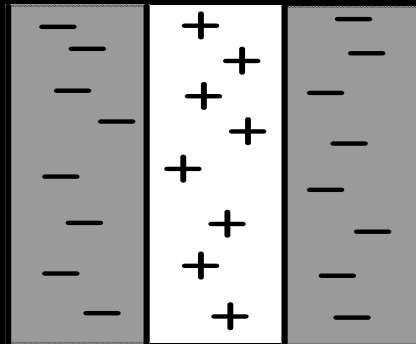

Firing Rate

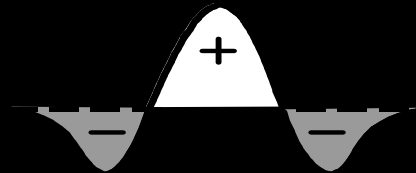

Horizontal Position

B. Dark Line Detector

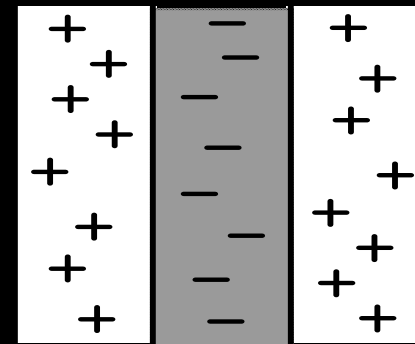

Firing Rate

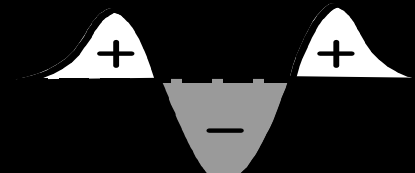

Horizontal Position

Simple Cells: Edge Detectors

C. Dark-to-light Edge Detector

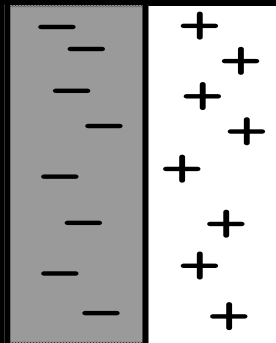

Firing Rate

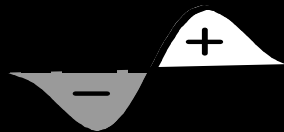

Horizontal Position

D. Light-to-dark Edge Detector

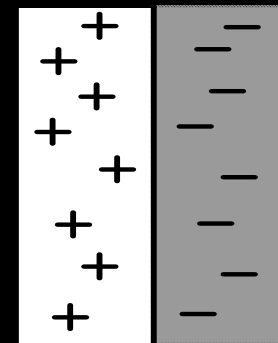

Firing Rate

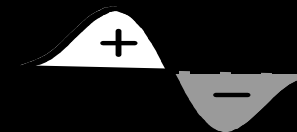

Horizontal Position

Orientation Dependence

STIMULUS



0°

NEURAL RESPONSE



STIMULUS



60°

NEURAL RESPONSE

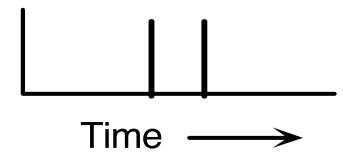

STIMULUS



120°

NEURAL RESPONSE

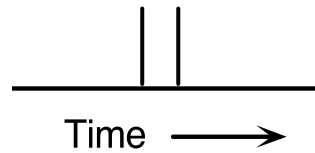

STIMULUS



90°

NEURAL RESPONSE

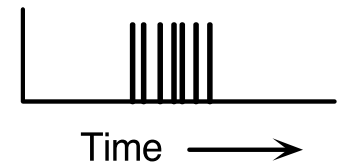

Simple Cell: Line Detector

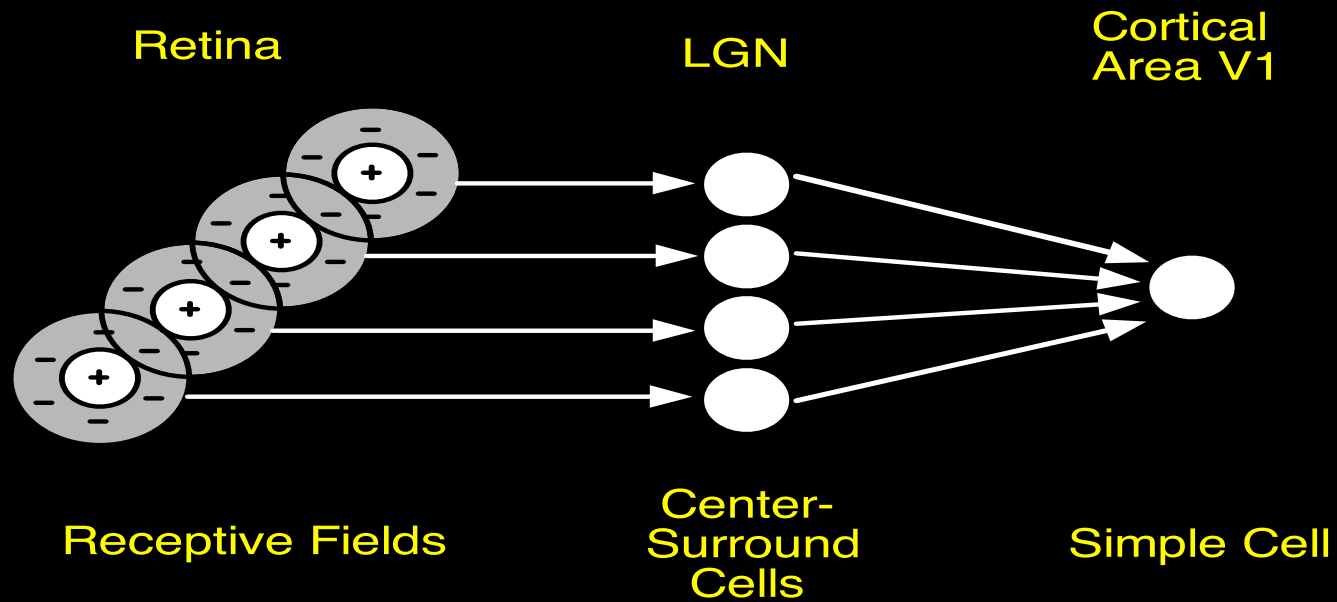

Complex Cell: Location-Independent Line Detector

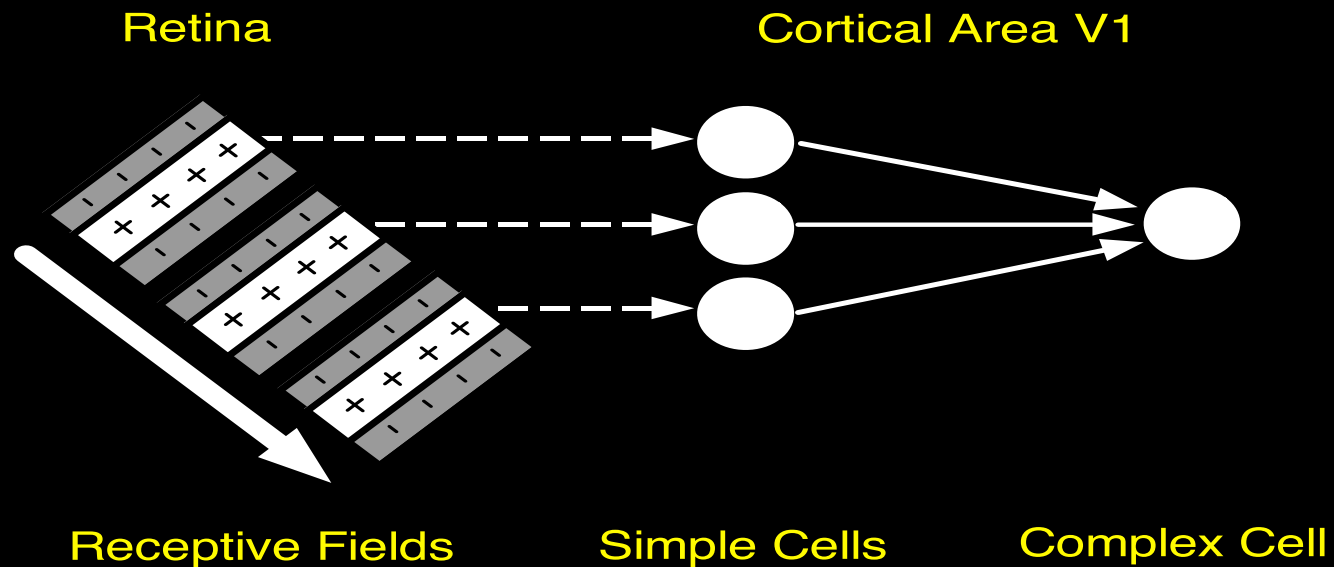

Retinatopic Map from Retina to V1

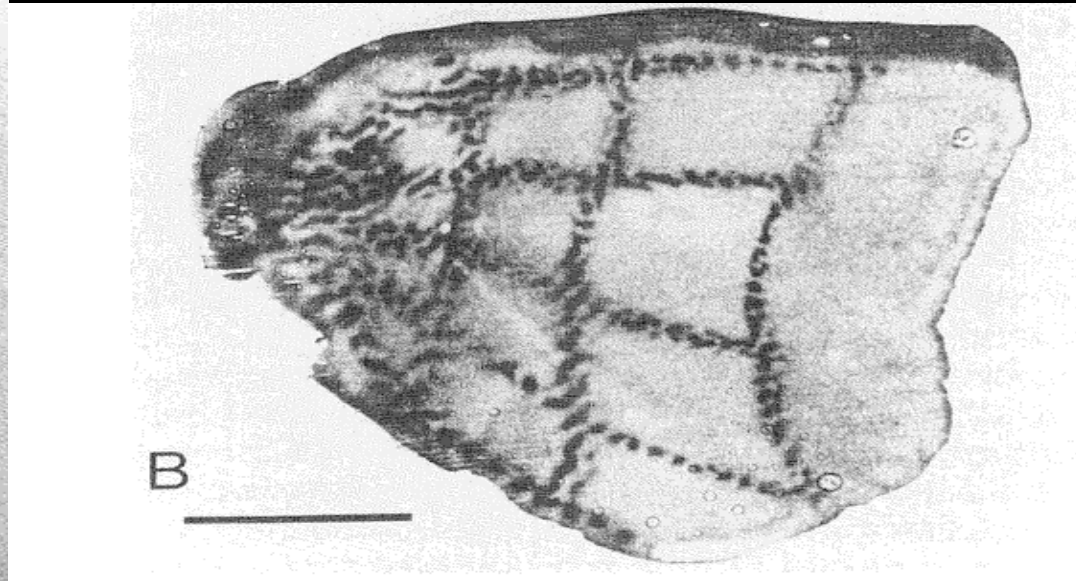
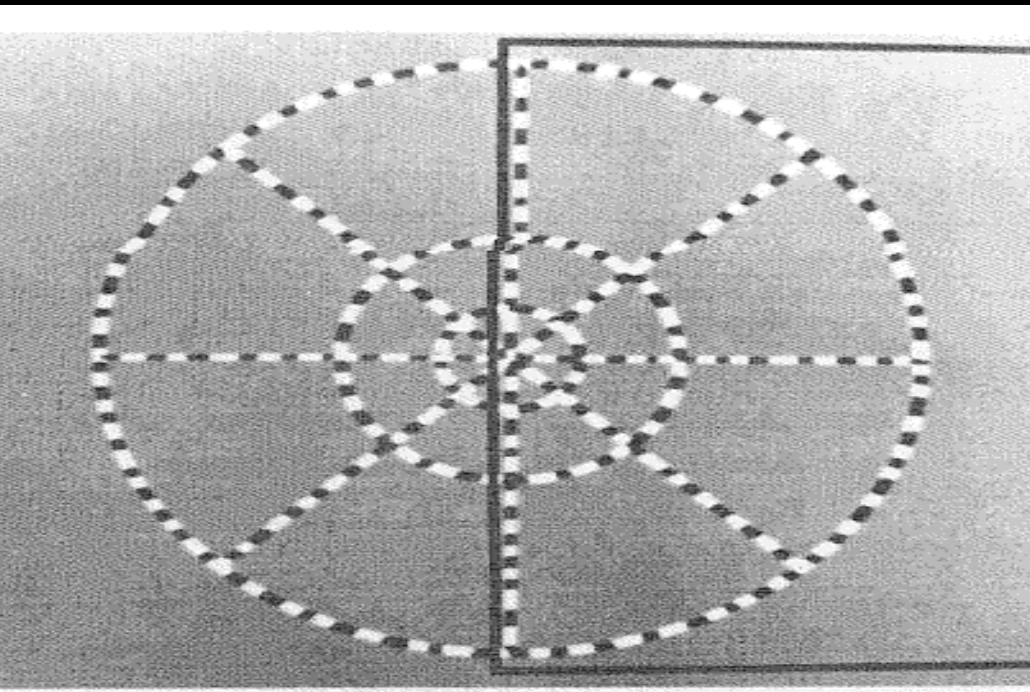

Convolutional neural nets (CNNs), LeCun, 1989. LeNet 5 classifier for handwritten digits.

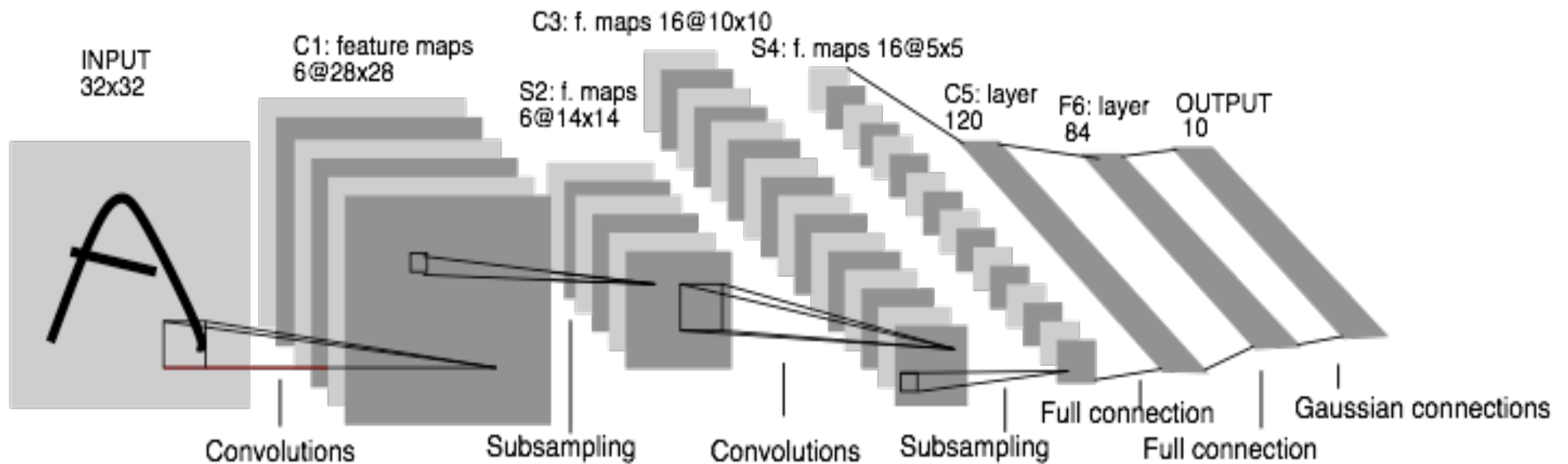

Convolutional Layer

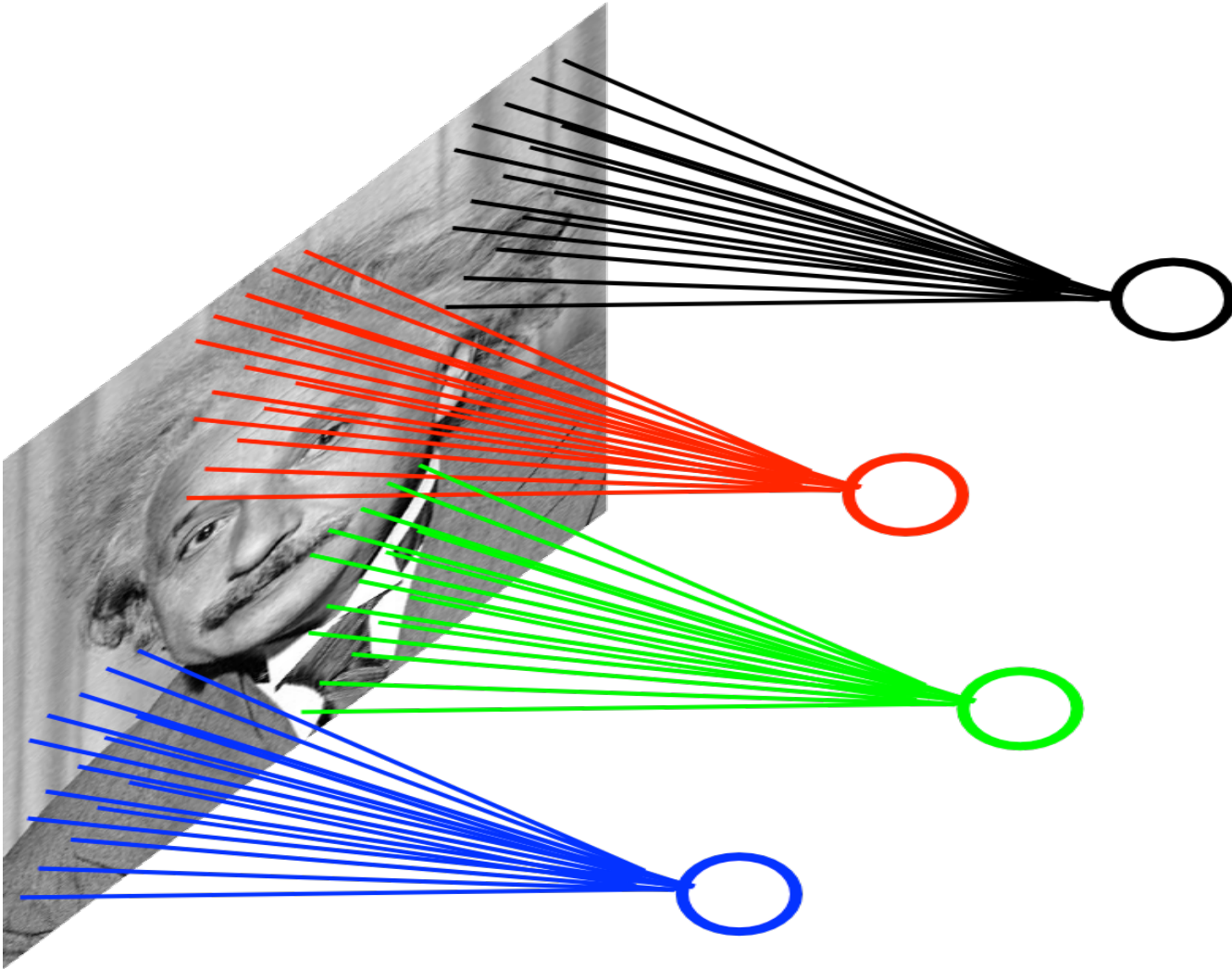

Convolutional Layer

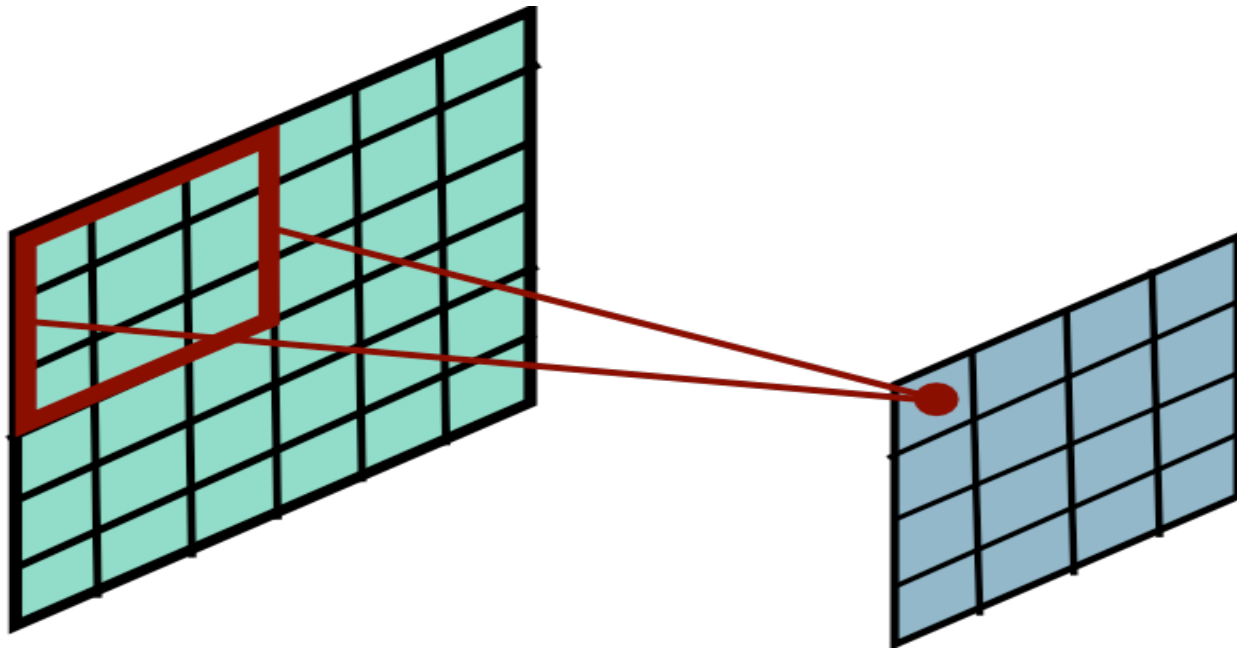

Convolutional Layer

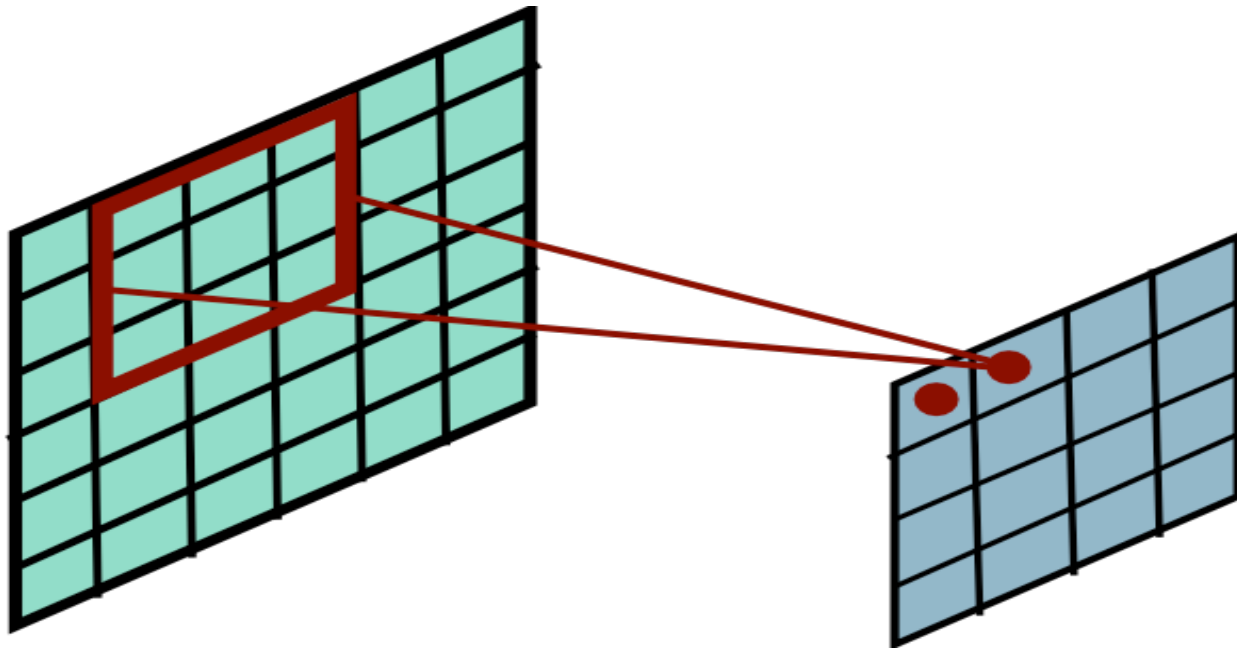

Convolutional Layer

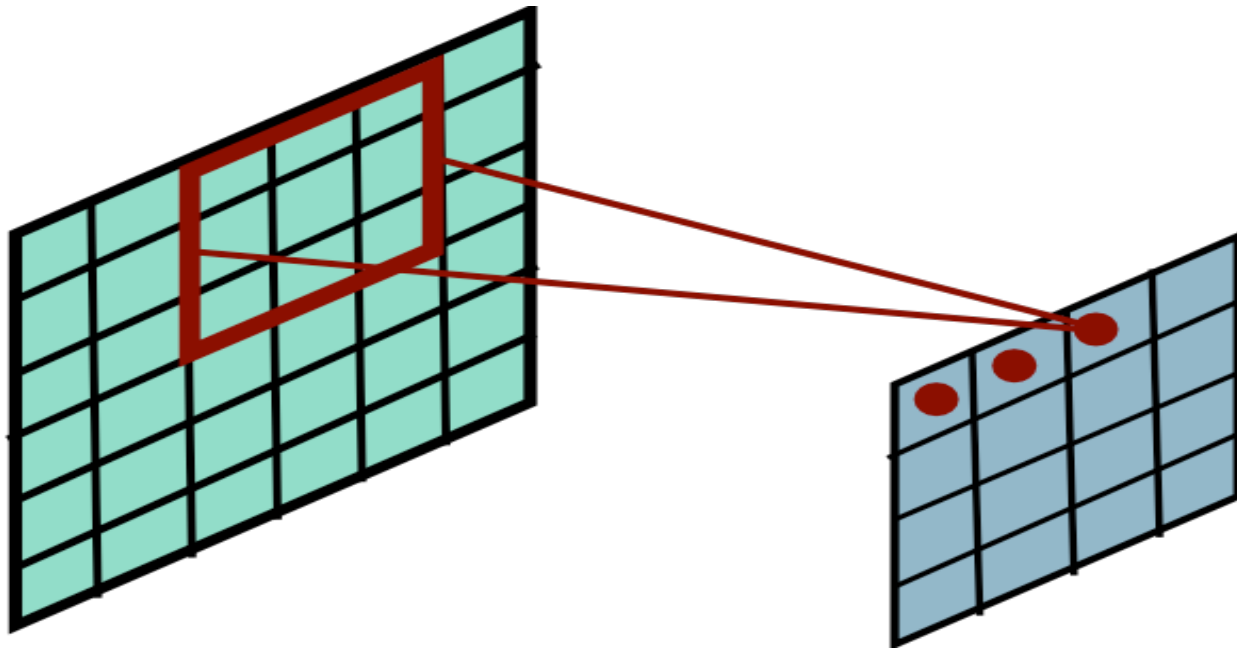

Convolutional Layer

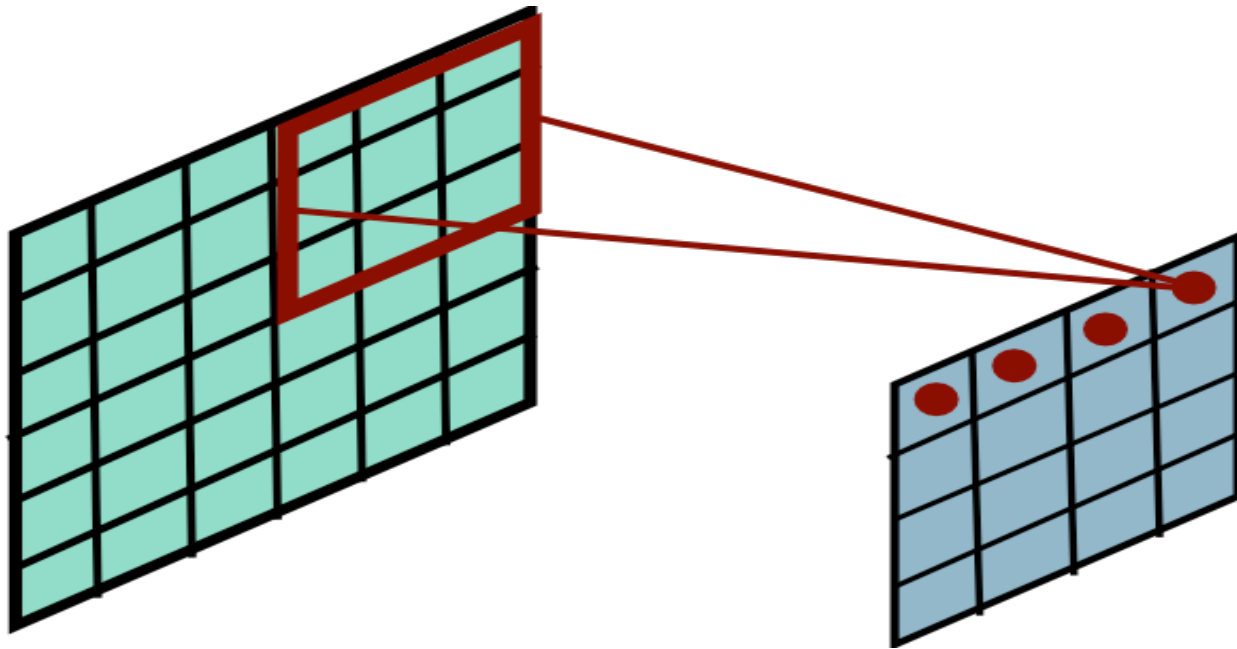

Convolutional Layer

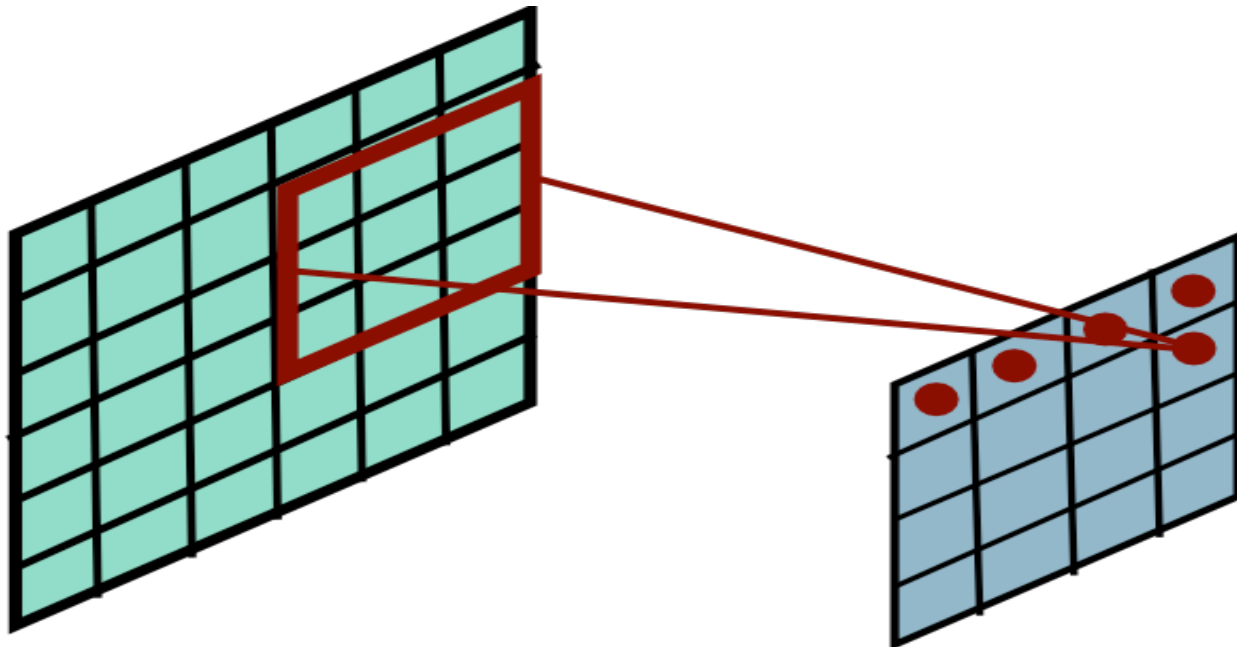

Convolutional Layer

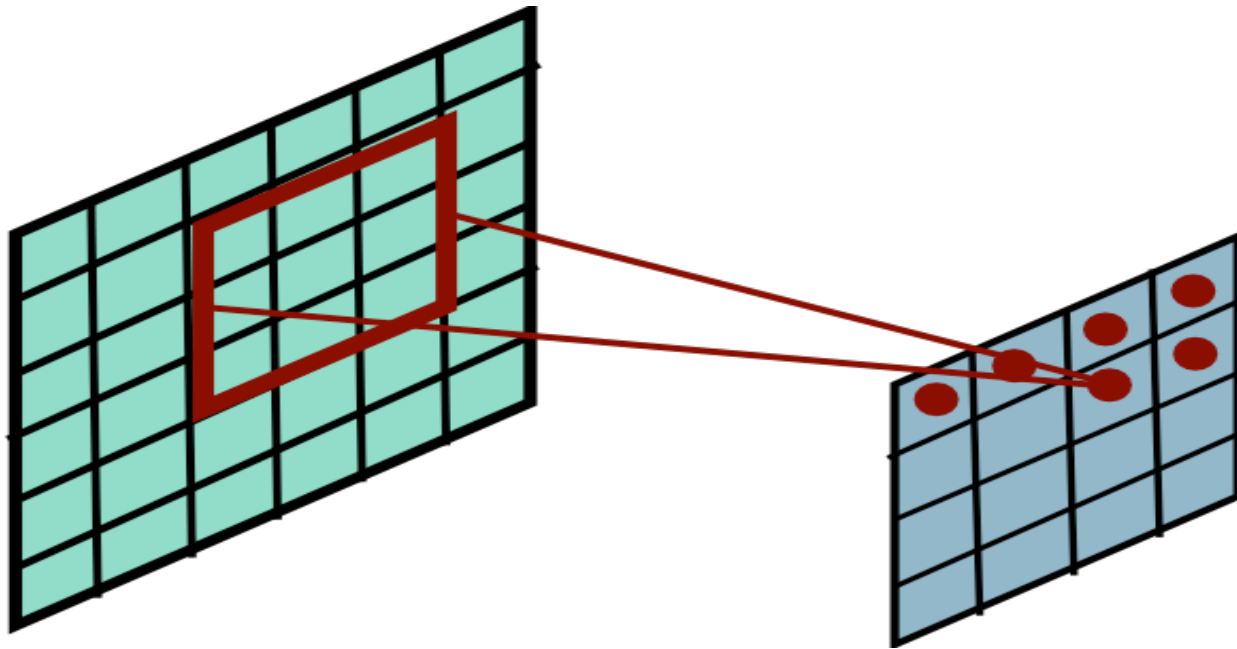

Convolutional Layer

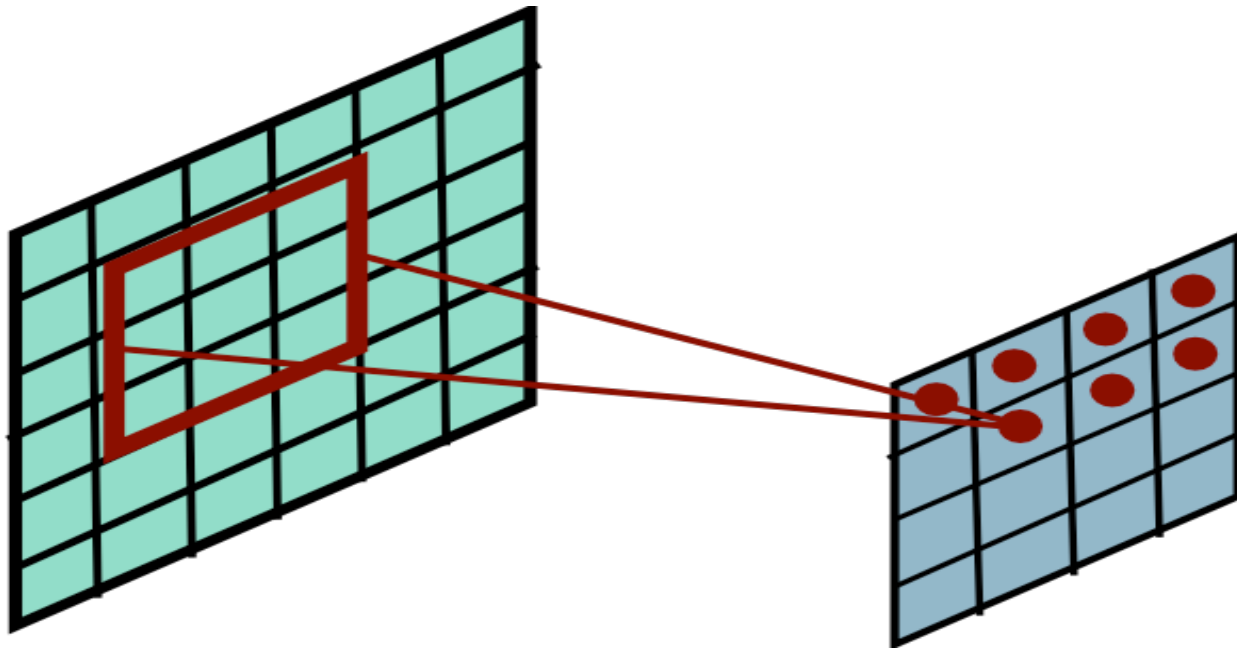

Convolutional Layer

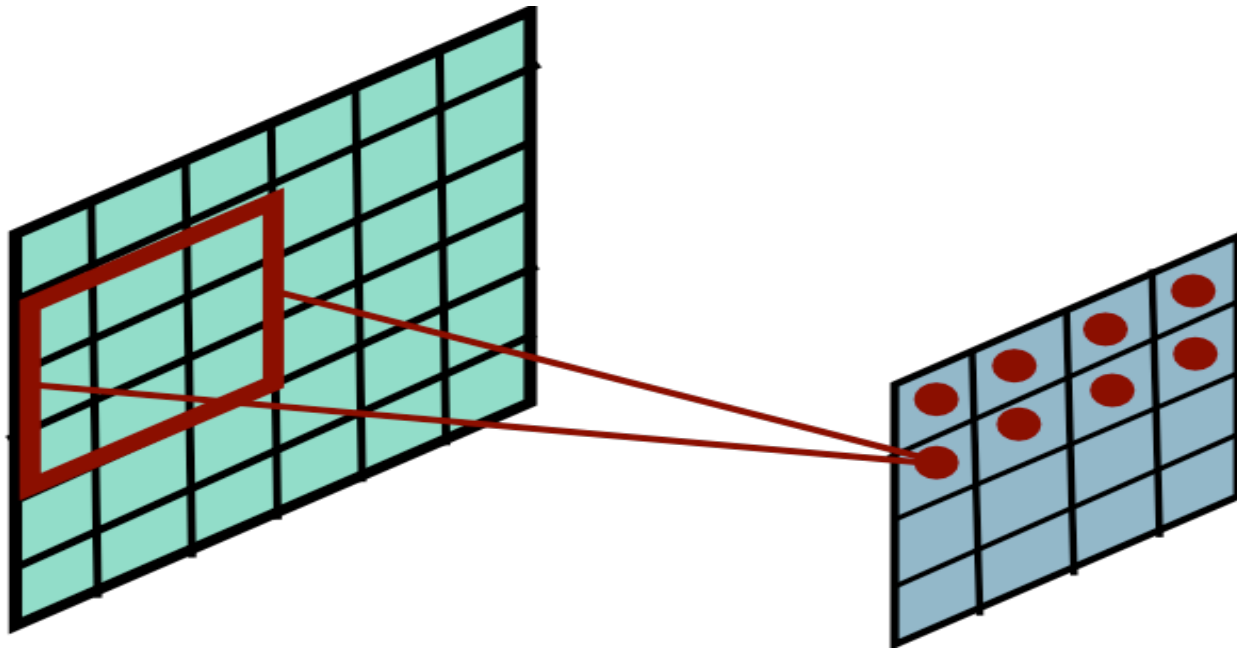

Convolutional Layer

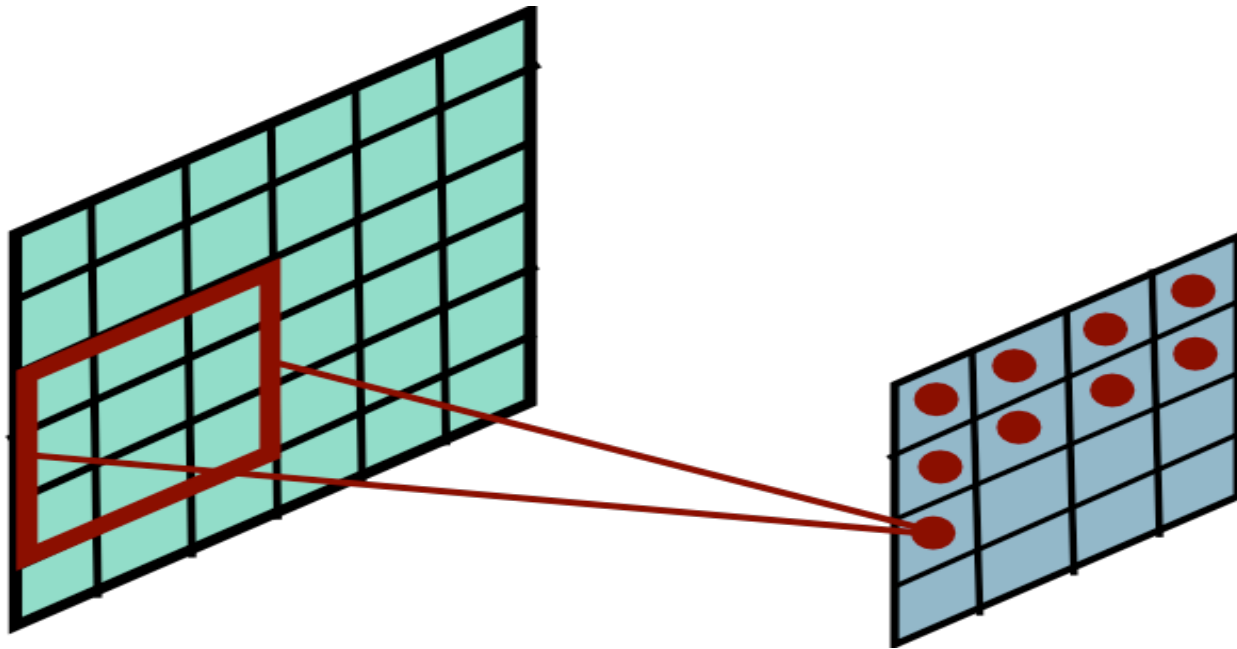

Convolutional Layer

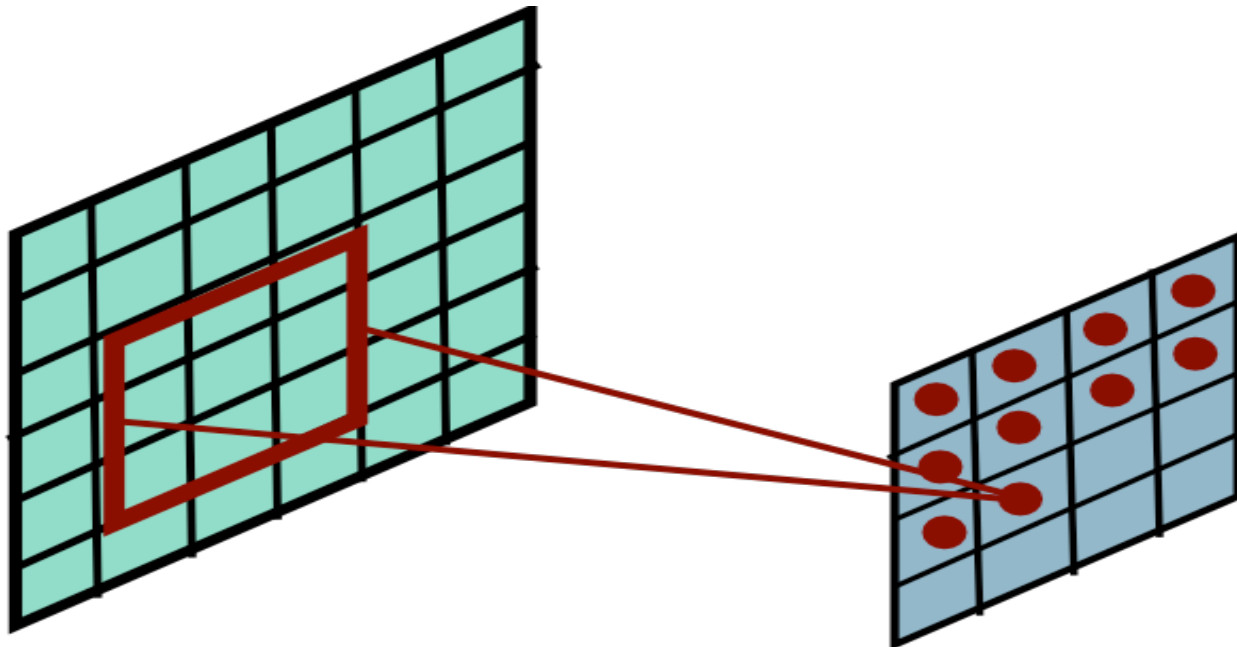

Convolutional Layer

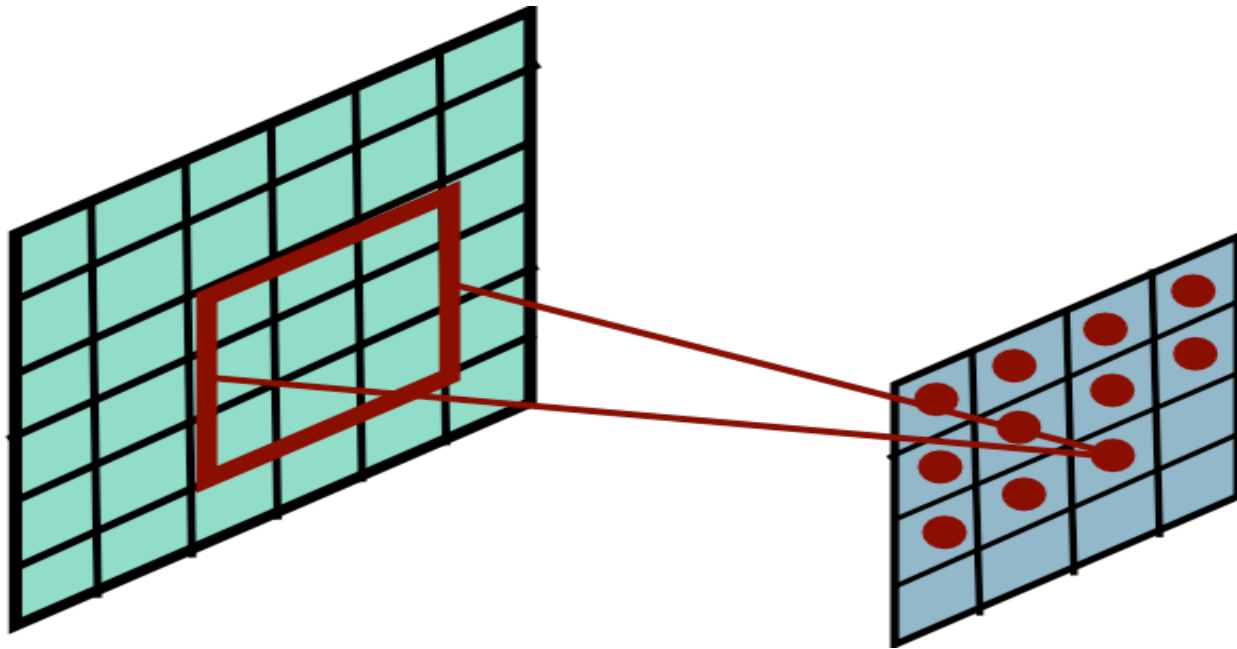

Convolutional Layer

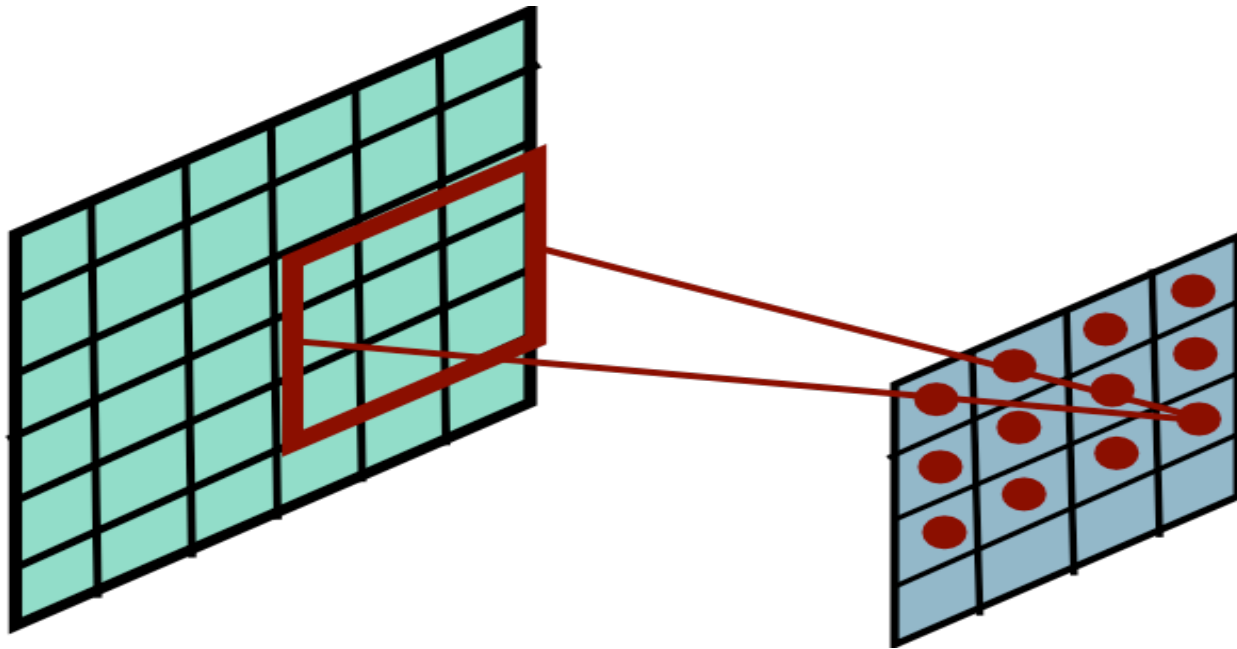

Convolutional Layer

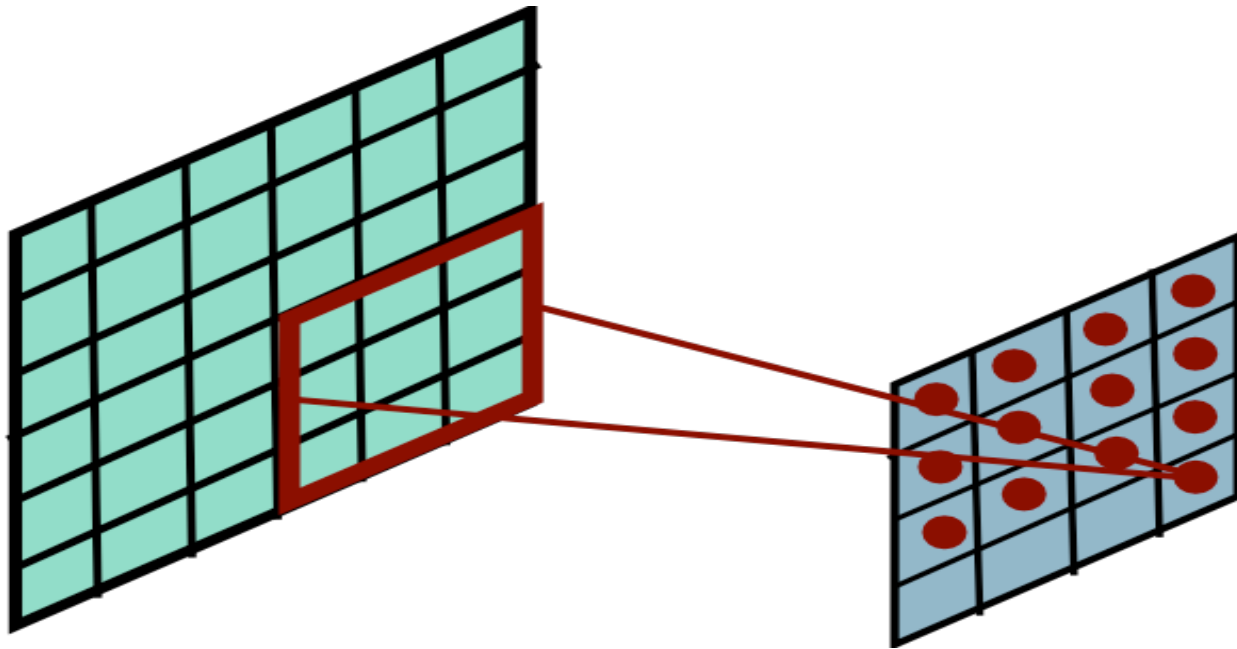

Convolutional Layer

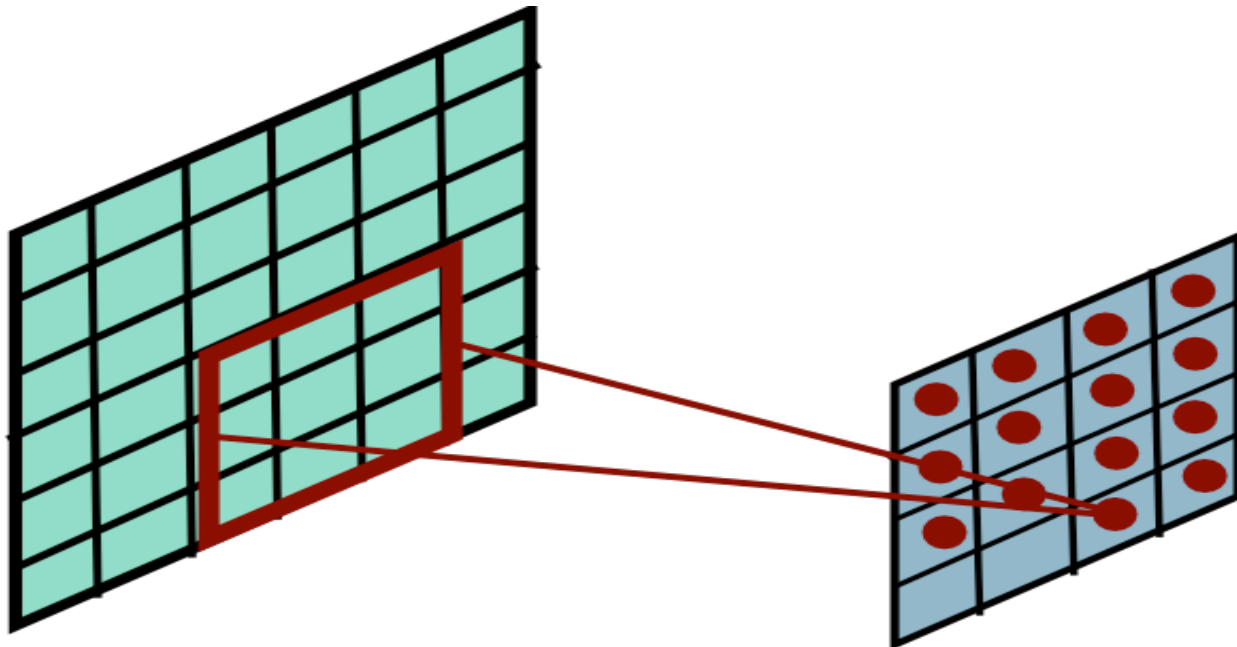

Convolutional Layer

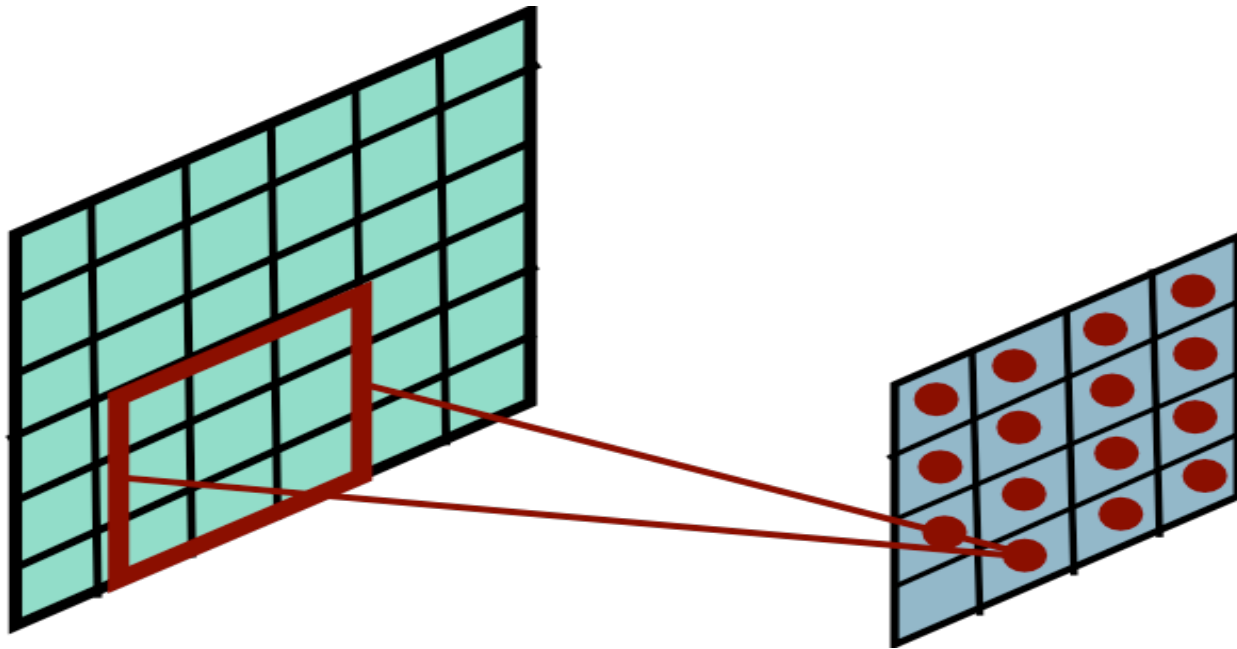

Convolutional Layer

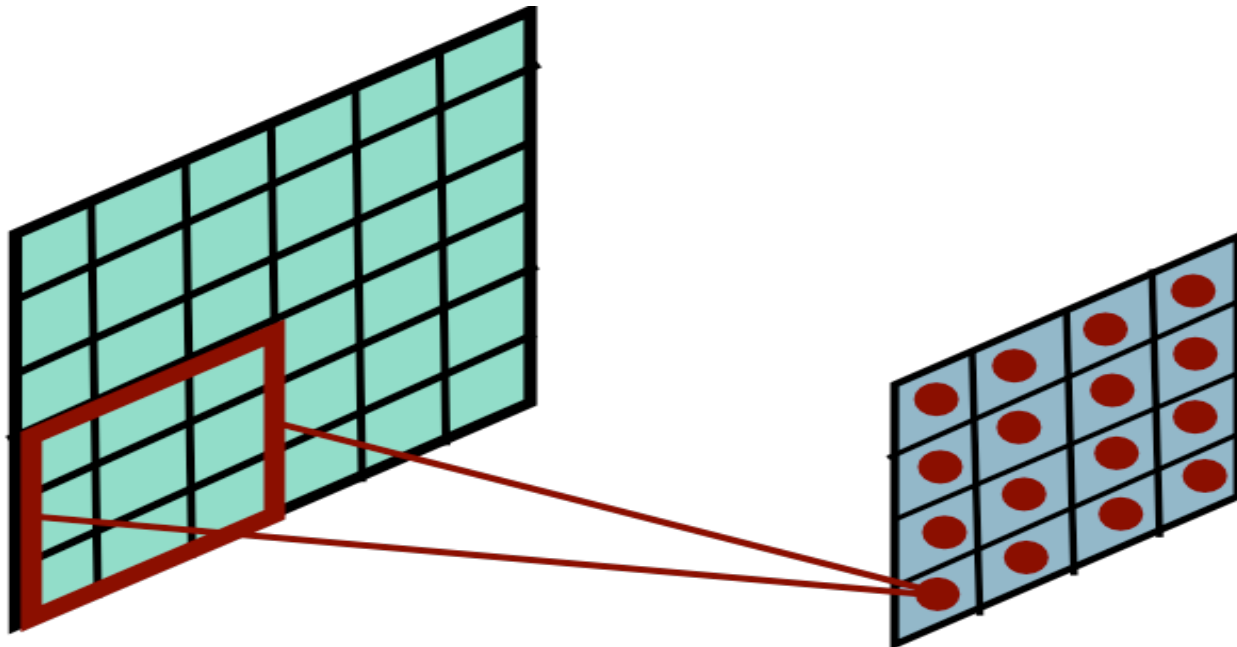

Convolutional of Two Signals



$$* \begin{bmatrix} -1 & 0 & 1 \\ -1 & 0 & 1 \\ -1 & 0 & 1 \end{bmatrix} =$$

mask

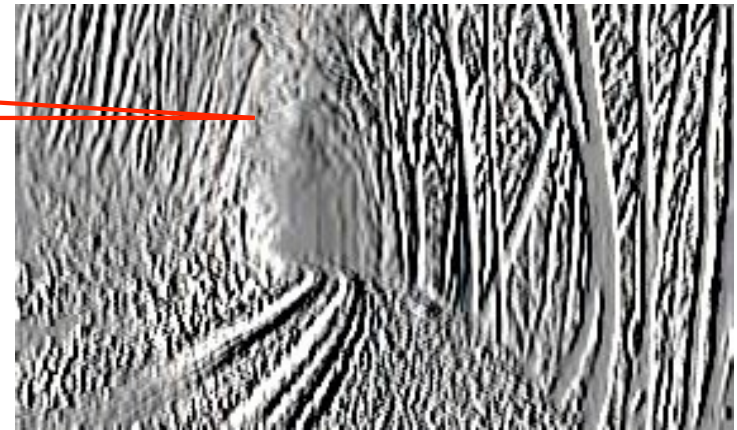

(vector, NOT a matrix!)

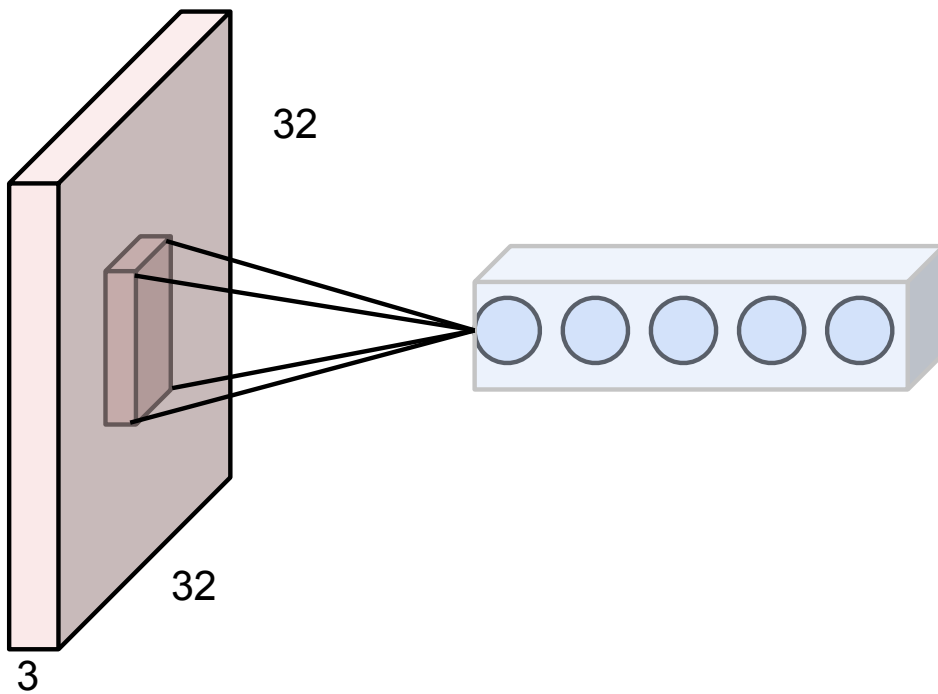

5 hidden units all looking at the same patch; 5 different masks.

Apply the same 5 masks to each patch = 5 units per patch.

Convolutional Layer

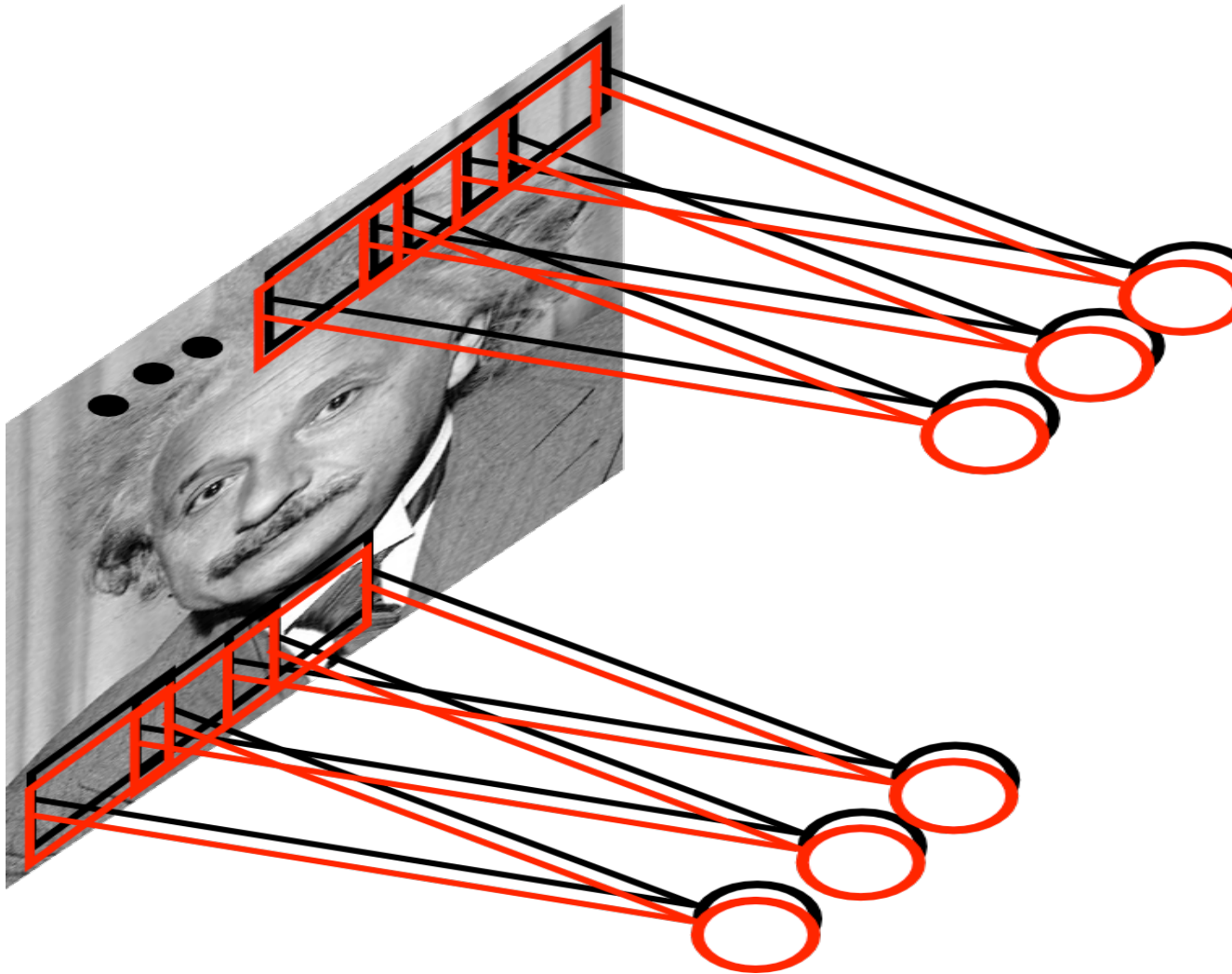

learned masks

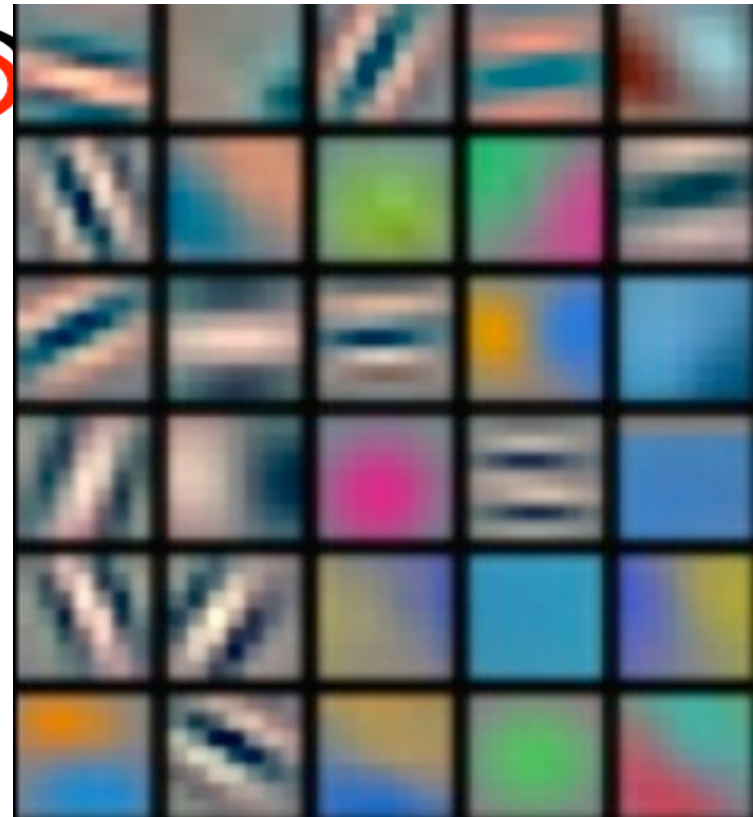

Activations:



convolving the input with the first mask gives the first output slice

Activations:

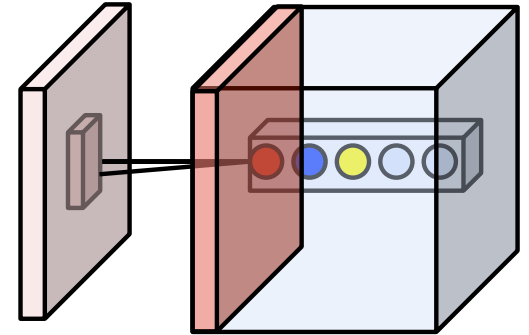
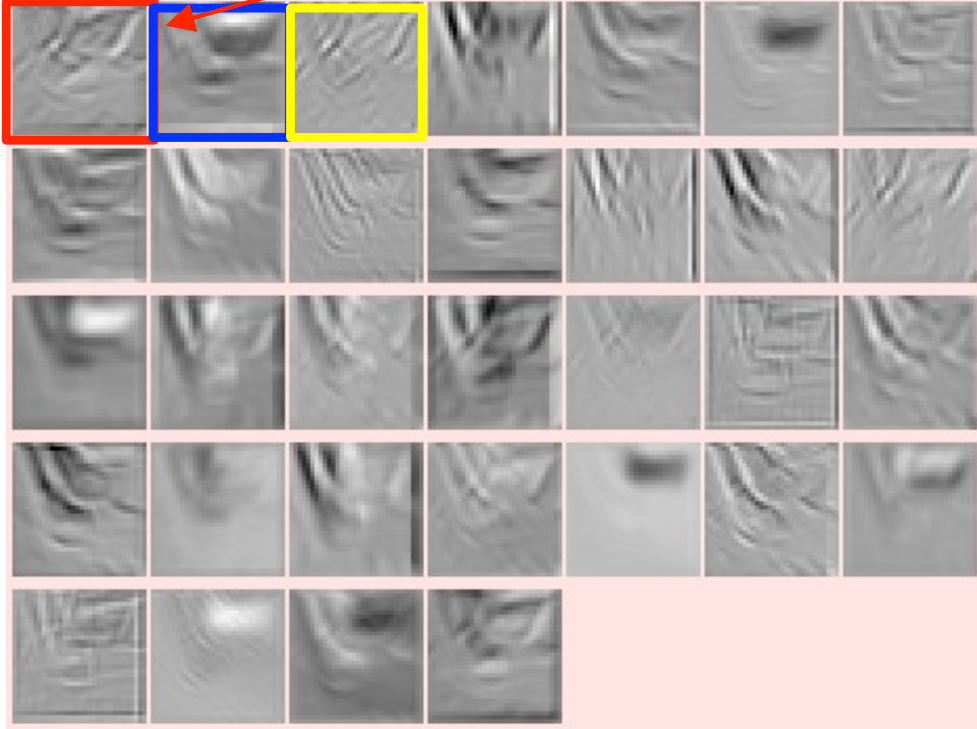

Convolution layers are often followed by pooling layers that shrink the image. Each pooled unit is the maximum of a 4-unit block. Hardwired, no weights to train.

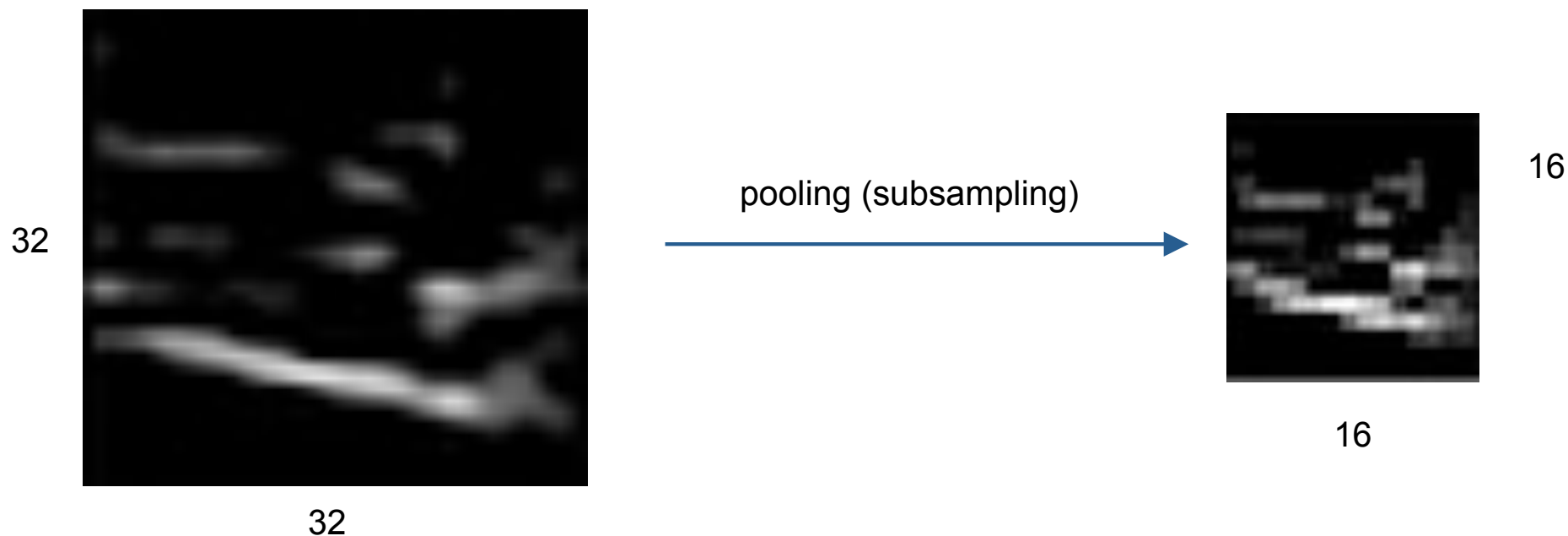

Convolutional neural nets (CNNs), LeCun, 1989. LeNet 5 classifier for handwritten digits.

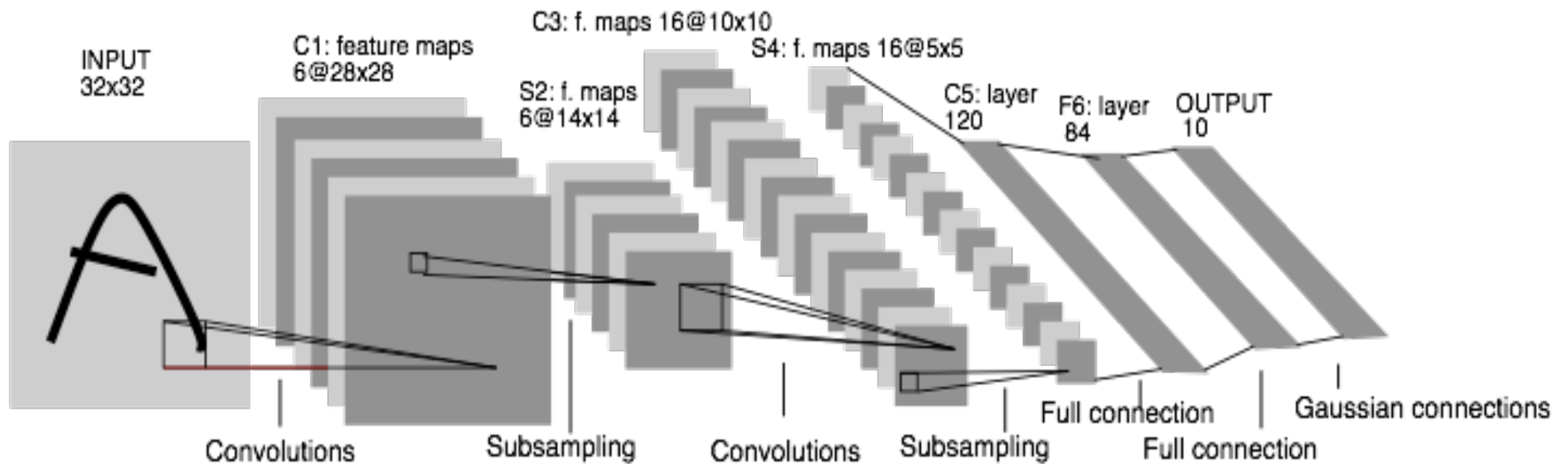

IMAGENET Large Scale Visual Recognition Challenge

Street drum

The Image Classification Challenge:
1,000 object classes
1,431,167 images



Output:
Scale
T-shirt
Steel drum
Drumstick
Mud turtle



Output:
Scale
T-shirt
Giant panda
Drumstick
Mud turtle



Convolutional neural nets, Krizevsky et al., 2012

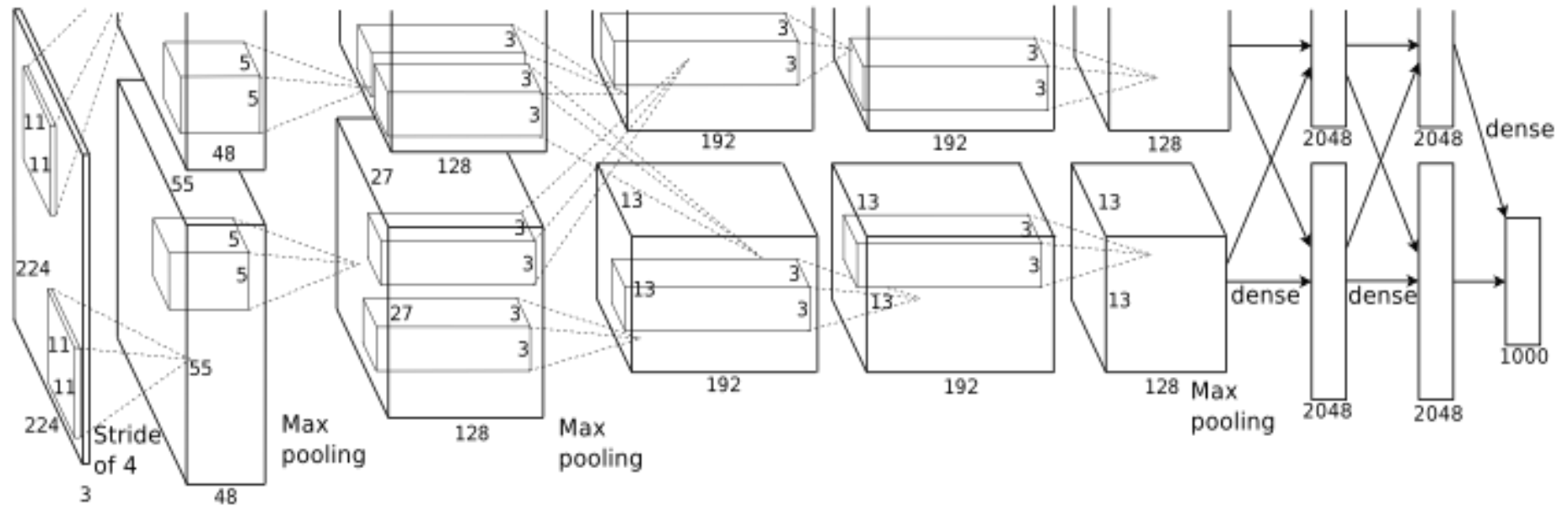

AlexNet: A competition-winning classifier for recognizing images in objects. The ImageNet Large Scale Visual Recognition Challenge, 2012.

- + millions of images
- + ReLUs
- + GPUs
- + dropout